

Our habitat project is based on some fundamental pillars, like every time:

- A. THE HUMANIZATION OF SPACE ARCHITECTURE
- B. THE USAGE OF INDIGENOUS MATERIALS AND NATURAL RESOURCES
- C. THE AUTONOMOUS CONSTRUCTION
- D. THE SAFETY
- E. EDUCATION: THE ADVANCEMENT AND THE TRANSMISSION OF KNOWLEDGE
- F. THE ECONOMY

A. The HUMANIZATION OF SPACE ARCHITECTURE

Thanks to human contribution to life and scientific advances, people will be ready to leave their natural surroundings with the aim of opening new horizons for future generations that will help create a settlement and home with newer and more advanced survival parameters.

In view of the feared and possibly expected attitudes of feeling trapped due to living in a limited space, the four crew members deserve a **habitat which will enable them to feel safe, calm and comfortable**. Consequently, this space has been **designed to encourage feelings of hope, excitement, luminosity, happiness and tranquility**. Our four tenants **will want to take shelter within the habitat; to watch a movie whilst eating popcorn...; to listen and/or to practice some music; to laugh and share fun games with each other; to rest; to have a coffee/tea/hot soup/freshly squeezed juice; to take a shower and to take care of their personal and/or general space; and amongst other things, to stay in touch with their base on Earth and share all necessary information and discoveries in addition to all their exciting experiences with them.**

In this manner, the idea behind the design creates a symbiotic relationship between SPORT, RESEARCH and LEISURE activities:



- SPORT. An indoor athletic track designed to encourage movement, sport and fitness:
 - The corridor to access each of the rooms is free of corners and its round shape adapts itself smoothly to the **natural movement** of the body as it turns.
 - It has been integrated as an **active surface** in the design.
 - It allows walking as well as **running or jogging** in order to incorporate a **healthy lifestyle** for its users.
 - It favors the principle of “**movement economies**” by fortifying more muscular strength with a lesser range of movement to ease the adaptability to the **ergonomy** of the surface and volume.
 - The above mentioned characteristics enhance the fitness levels of each crew member by: **increasing muscular mass and bone density; strengthening the immune system, preventing cardiovascular risks; boosting brain power; reducing depression;** all of which are intrinsic benefits of a sporty lifestyle.
- RESEARCH. The rooms have been thought out to combine science with the wellbeing of the tenants. This includes:
 - A **linear kitchen with a long seating areas**. The ample space of this space allows for the integration and installation of necessary facilities that will favor the life of its users, such as a fridge, a washing machine, a dishwasher, a microwave/oven, a cooking stove,

a sink, cupboards and food storage. It also has a large bar-style table to serve the purpose for eating and drinking together as well as to carry out research and developmental groupwork.

- Independent spaces for **information, communication and technology systems**.
- An independent room as **laboratory and clinic for health control and treatment**.
- **Four comfortable double (or single) rooms** furnished with a **round wall-mounted table**, which adapt to the smooth outline of the curvy and round walls.
- Hydroponic plantations **located in the center of the habitat, giving room for food and astrobiological research**.
- **Floor composed for storage boxes**.

• **LEISURE. A common area for relaxation and recreation.**

- This is an ample and open-plan lounge, with ball puffs and low tables spread out to serve the purpose of **feed and entertainment**. This space will also have a lightweight, wide and round TV screen to improve visibility from any angle, and a surround sound system. The **open-plan layout connected to the kitchen** shares the **natural daylight and views of the big window in the ceiling**. This allows the tenants to enjoy **practicing music amongst each other, playing board games with a movie theater-like ambience where it is also possible to enjoy home-made drinks and snacks, and relax in a friendly environment**.
- All main rooms have This room will also have two lightweight, wide and round TV screen to improve visibility from any angle, and a surround sound system.
- The **hexagonal big window over the central area of the habitat** create a **sensation of open space to the exterior, with outdoor window views**, providing the tenants with the **possibility to look beyond the immediate sky**.

The **dome structures of the rooms**, with its curved shapes/ceilings, provides a shelter and protects its tenants from external inclemencies, and preserve them from the **from the damaging solar UV irradiation** too, for its interior composition.

All this, helps to convert the habitat into an **active enclosure, which attracts the visitor due to the great concentration of activities** that can be carried out in its interior space, its **warmth**, and the possibility of holding **workshops** with both hydroponic crops, as well as laboratories, with **all the necessary services for a pleasant and complete stay**, within an enclosure with interrelated areas, sufficiently **illuminated and pleasant**, as a limited protective shelter but ample shelter from which to schedule walks on the lunar surface in large groups, and even exercise inside it for its space well used (with plenty of room to move), and disposition.

Also, **always connected to the Earth by the number of telecommunication devices and worksattions**, with their own screens (included both in common spaces and in the bedrooms), in order to continuously monitor and maintain at all times the vision of the situation on Earth, and the relationship with it.

LIVING SPACE IN FOCARIS			
Number	Space	Area	Volume
1	Airlock A	23.67 m ²	70.65 m ³
2	Airlock B	23.59 m ²	70.65 m ³
3	Control Post	8.16 m ²	21.42 m ³
4	Kitchen - Lounge	25.07 m ²	68.00 m ³
5	Telecommunications Post	8.16 m ²	21.42 m ³
6	Laboratory - Treatment R.	25.07 m ²	67.99 m ³
7	Hydroponic Plantation	11.10 m ²	33.29 m ³
8	Room 1	9.05 m ²	21.14 m ³
9	Room 2	9.05 m ²	21.14 m ³
10	Room 3	9.05 m ²	21.13 m ³
11	Room 4	9.05 m ²	21.14 m ³
12	Room 5	9.05 m ²	21.14 m ³
13	Room 6	9.05 m ²	21.13 m ³
14	Room 7	9.05 m ²	21.06 m ³
15	Room 8	9.05 m ²	21.03 m ³
16	Restroom	18.46 m ²	43.18 m ³
17	Walking/Running Track	78.62 m ²	207.25 m ³
Total general: 17		294.31 m ²	772.77 m ³

Water Requirements	Potable (Kg/p-d)	Hygiene (Kg/p-d)	Reference	POTABLE (Kg/p-d)	Vol. m3 p. d.	Vol. m3		
Human water needs			(Eckart, 1996)	Liquid	1,6 0,0016 14 180	4,032		
Drinking	1,60			Liquid	0,75 0,00075 14 180	1,89		
Preparing food	0,75			Food	1,15			
Water in food (estimate)	1,15			Liquid total		5,922		
Hygiene			(Eckart, 1996)	Water Tank: Dome 1		4,5		
Shower		2,70		Water Tank: Dome 2		4,5 %	Days	
Hand wash		4,10		Reservoir Total		9	151,98%	274
Housekeeping	N/A		(Eckart, 1996)	Necessary to Recycle		-3,078	-51,98%	-94
Laundry		12,50						
Dishwashing		5,50		HYGIENE (Kg/p-d)	Vol. m3 p. d.	Vol. m3		
Urinal Flushing		0,50		Liquid	25,30 0,0253 14 180	63,756		
				Liquid total		63,756		
Crew activities			(Eckart, 1997; ISU, 1993; NASA, 1992)	Water Tank: Dome 3		4,5		
Medical	5 Kg/event			Water Tank: Dome 4		4,5		
Experiments	depends on mission			Water Tank: Dome 5		4,5		
EVA - cooling	7,3 Kg/EVA			Water Tank: Dome 6		4,5		
				Reservoir Total		18	28,23%	51
				Necessary to Recycle		45,756	71,77%	129

Waste Collection System	Mass (Kg)	Units	Volume (m ³)	Units	p	d	Mass (Kg)	Volume (m ³)	FOCARIS	Upshot	Units
Waste Collection System	90 Kg		4,36 m ³				90,00	4,36	4,50	0,14 m ³	
WCS supplies	0,05 Kg/p/d		0,0013 m ³ /p/d	14	180		126,00	3,28	4,50	1,22 m ³	
Contingency fecal and urine collection mittens/bags	0,23 Kg/p/d		0,0008 m ³ /p/d	14	180		579,60	2,02	4,50	2,48 m ³	
Waste Collection System	Units	Width	Depth	Height	Area	Vol.	Volume (m³)				
Restroom	1,00				18,46		18,46				
Lower Lounge	1,00			0,30	2,85		0,86				
Lower Restroom	1,00			0,30	8,17		2,45				
							3,31				
							1,90				
							1,41				

B. **THE USAGE OF INDIGENOUS MATERIALS AND NATURAL RESOURCES.**

The **habitat challenges to use the available extraterrestrial resources**, besides of terrestrial ones, found on our closest habitable planet with the aim to establish a possible human settlement, **changing as little as possible the planet** to be colonized.

Taking into account the previously outlined philosophy, the proposed habitat embraces **four key concepts**:

1. **“In situ” resources**;
2. **Recycling**; and
3. **Geoethics and Astrobioethics**.

The following explains the importance of each of these four concepts in the development of our project.

1. **“In situ” Resources**

- **The mixture**:

For part of the construction of the habitat (inside the walls) we propose using a mixture consisting in most part of **lunar regolith**, as component of the dust on the surface of Moon, and **water**. This will provide the tenants of the habitat with a natural form of protection against radiation.

In this respect, the **site proposed for the construction of the habitat** is located at the **South Pole of the Moon**, more specifically **close at 89.54 degrees south latitude and 0.0 degrees east longitude**; an **area close to the crater Shackleton**. The two main reasons for the choice of this location are: a) the peaks on the edge of the crater are exposed to the sunlight in an almost continuous ways and, b) the proximity to possible ice made out of water.

- **Sunlight as a natural source of energy, in addition to nuclear energy**:

The plan is to use **Solar panels** –with solar collectors- **to capture caloric energy and Photovoltaic panels** for electrical generation. (The use of nuclear energy for periods of low luminosity is TBD)

- **Luminosity Control Mechanisms and Human Motion Detectors**: these will consist of computer controlled devices located inside the habitat with the end goal of **saving energy and making the habitat more environmentally friendly**.

2. **Recycling**.

Resources supply containers will be available **in the spacecraft** used for the Moobn mission. These containers will be recycled and their specific shape altogether will be used as **exterior walls and a suspended floor in the habitat** achieving the following benefits: **a) to contribute to the recycling of the materials coming from Earth; b) to decrease the take-off weight of the spacecraft when, once the moment arrives, returning to Earth; c) to make the most of the habitat surface; d) to facilitate wiring and piping; e) to improve the habitat isolation (temperature and radiation); f) to provide, orderly, space for food storage and equipment that the crew need for stay in the habitat.**

3. **Geoethics and Astrobioethics**.

One of the main tasks of a working group on astrobioethics which has been recently established, will be “to analyse the potencial societal and ethical implications related to

astrobiology, **taking into account the complexity of the connections between its main scientific issues and goals** (see, for instance, the NASA Astrobiology Institute Astrobiology Roadmap), and **considering the synergies between both bioethical and geoethical approaches (from microbes to humans and from the Earth to space environments)**". (Martínez-Frías, J. and Gargaud, M.Hochberg D.)

In this sense, "with the recent increase in the exploration and research of the planets and celestial bodies, planetary geoscience is one of the fastest –growing branches of the geosciences, and there is a great variety of geoscientific aspects which connect with astrobiology". (Martínez-Frías J and Hochberg D (2007) Inter. Sci. Rev. 32-4:315-319)

The **proposed habitat aims to avoid possible hazards of settlement provoked by man** by taking care of the new land which shall provide shelter for the colonists. In this way, we agree with Holmes Roston III, who states "**We confront a projective nature, one restlessly full of projects – stars, comets, planets, moons, and also rocks, crystals, rivers, canyons, seas. The life in which these astronomical and geological processes culminate is still more impressive, but it is of a piece with the whole projective system... Nature is a fountain of life, and the whole fountain – not just the life that issues from it – is of value**" (Rolston, 1988, p.197).

C. **THE AUTONOMOUS CONSTRUCTION**

As detailed in the PDF panels, **the habitat can be built by means of parts of the rocket itself and lightweight precast material, easy to assemble.**

The envelopes of the rooms will include:

- **Space-Grade Insulation:** to insulating the habitat and keeping astronauts comfortable in their spacesuits.
- **Pleated Domes:** with the **operation like folding paper fans**, with several peripheral hooks to effect an airtight closure, occupying the minimum space inside the rocket and opening once on the outside; of little weight. They will hold the structural stresses created by the atmospheric pressure inside the habitat rooms, and they will also reduce the construction time, increase the durability and mitigate the effects of icing/de-icing cycles, abrasion, and shock impacts of the habitat, as retractable plastic covers.

All the **supple containers and the metal parts** from the envelope of the habitat, are designed with diameters and radius curves similar to the possible rockets used for the mission, as the BFR Starship/super heavy, from SpaceX, or another one. This **allows us to reuse materials easily, and reduce costs**, by **standardizing** the shapes.

On the other hand, the **upper structural shell** of the building, with its **hexagonal shapes of light**, provides a **shelter and protects its tenants** from possible external contingencies and inclemencies. In addition, it **serves as a reference point** for astronauts who must move away from the habitat during exploration hours.

New technologies and a more developed design have been integrated according to a new era in an environment where there is still much more to explore.

D. **THE SAFETY**

In case of emergencies, such as depressurization, contaminated atmosphere, fire or any system failure jeopardizing the crew life, the following **procedures have been planned** for:

- 1) When the **habitat** exists **as an independent module** the **possible escape exits** are: **via the two main access** existing, through which **a group of fourteen users, either regular or visitors, can go outside at a time.**
- 2) When the **habitat** is a **part of a larger colony** (or more than one habitat exist): in any case of emergency the possible colony arrangement of the habitats allows the evacuation of any habitat: **a) through flexible booths at the interconnection point to the adjacent habitat;** and **b) nearby connected habitats.**

In both options, there are planned **points of access with open/closed doors detection system** to avoid depressurization in areas vital for crew survival.

On the other hand, the **structural plain shell** of the building, with its **hexagonal illuminated shapes**, provides a **shelter and protects its tenants** from possible external contingencies, as possible impacts of celestial bodies, and it is shown as an easy point visible from a long distance, outside as a **support for exploration outside the habitat.**

ASSEMBLING THE PLEATED DOMES

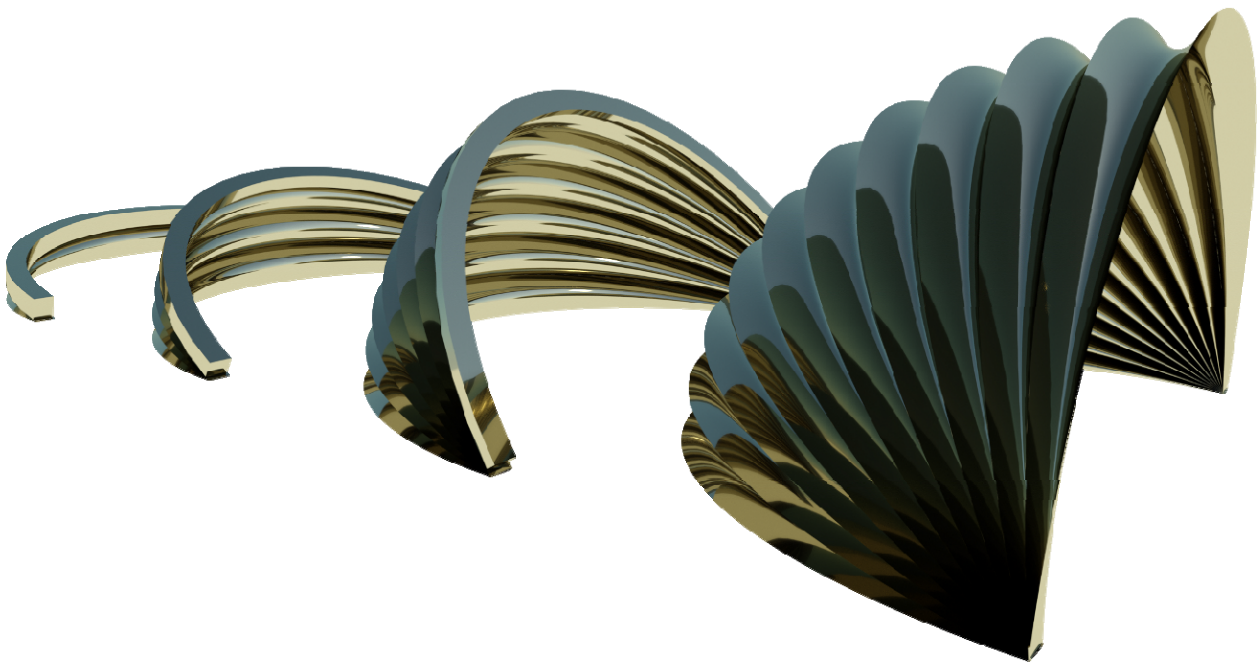

E. EDUCATION: THE ADVANCEMENT AND THE TRANSMISSION OF KNOWLEDGE

We consider it important to project a habitat intrinsically capable of having the ability to approach open / shared and closed spaces, from which to analyze, learn and transmit. Thus, we intend that, from there, you can connect with society, transmitting each of the new research results that arise from within these spaces, including those related to the possible habitability inside the enclosure itself, and with the technological contributions that this entails, in order to facilitate the human being (as an independent individual, and as an integral part of a society) its evolution in the field of scientific-technical knowledge, among others, also setting learning, as an objective, so that We can expand our ability to react, in advance, to the challenges that the environment offers us today, as well as the thousands of them that it may offer us in the future. In this way, we will be able to expand our chances of survival both in the terrestrial environment and in the extraterrestrial environment.

F. THE ECONOMY

We present a model of habitat of easy construction, taking into account that it must be built in the lunar environment (by humans in rather uncomfortable suits), **and economic, given the seven main points on which the project idea is raised**, as it has been explained in the previous text, and it can be observed:

- 1) The **Prefabrication**, with convertible elements, making the minimum space, prepared on Earth;
- 2) The **Speed of Assembly**, given the previous point;
- 3) The **Modulation**, based on the rocket, of the constructive and mobile elements;
- 4) The **Standardization**, using similar measures for construction elements and furniture, in the maximum spaces where it has been possible;
- 5) The **Efficient Use of Interior Space**, with maximum use of walkable space;
- 6) The **Type of the Materials** used, all known and feasible; and,
- 7) The **Usage of Indigenous Materials and Natural Resources**, very easy to group from the lunar surface, reducing the cost of fuel and weight of the rocket, during its journey...

STORAGE FOR THE TRANSPORT OF PARTS OF THE FOCARIS HABITAT

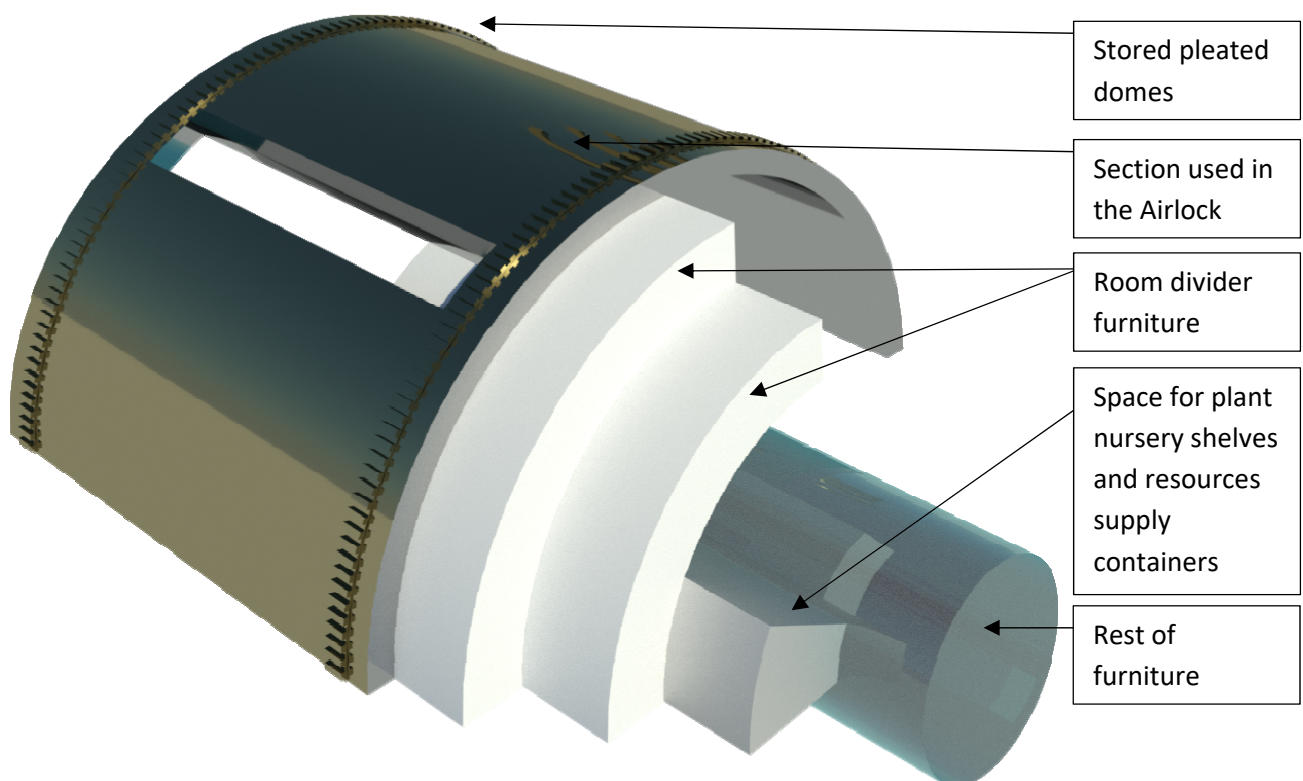

All the elements of the Focariss habitat can be transported in a cylindrical conceptual volume, 8 meters in diameter by 8 meters in height. It could be a section of the space vehicle used to travel to the Moon.

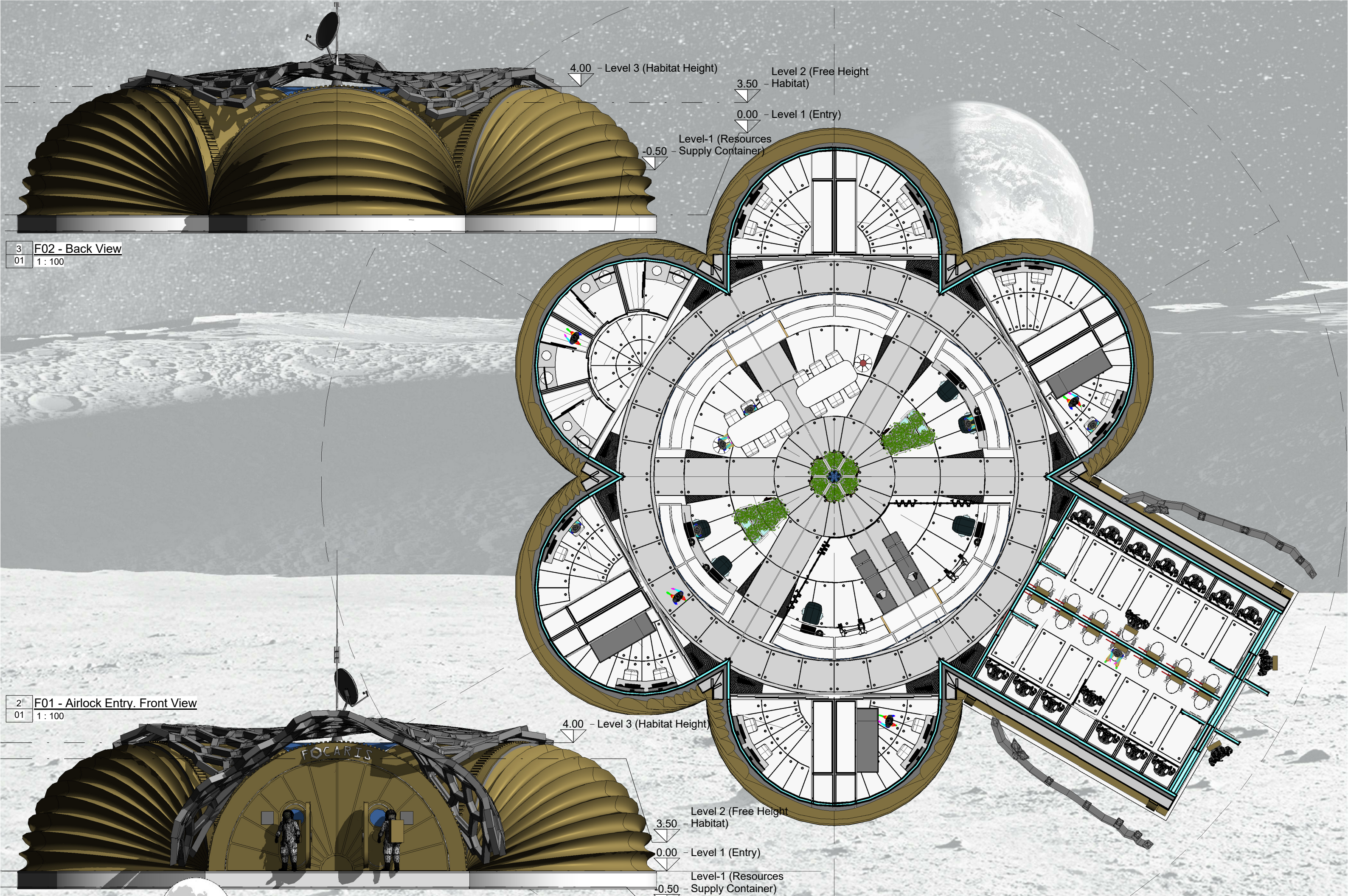

3 F02 - Back View
01 1 : 100

2 F01 - Airlock Entry. Front View
01 1 : 100

PROMOTE:

THE MOON SOCIETY

PROJECT'S NAME: FOCARIS

N° 01. FLOOR PLAN AND FRONTS PLANS

FOCARIS

- Airlock A
- Airlock B
- Control Post
- Hydroponic Plantation
- Kitchen - Lounge
- Laboratory - Treatment R.
- Restroom
- Room 1
- Room 2
- Room 3
- Room 4
- Room 5
- Room 6
- Room 7
- Room 8
- Telecommunications Post
- Walking/Running Track

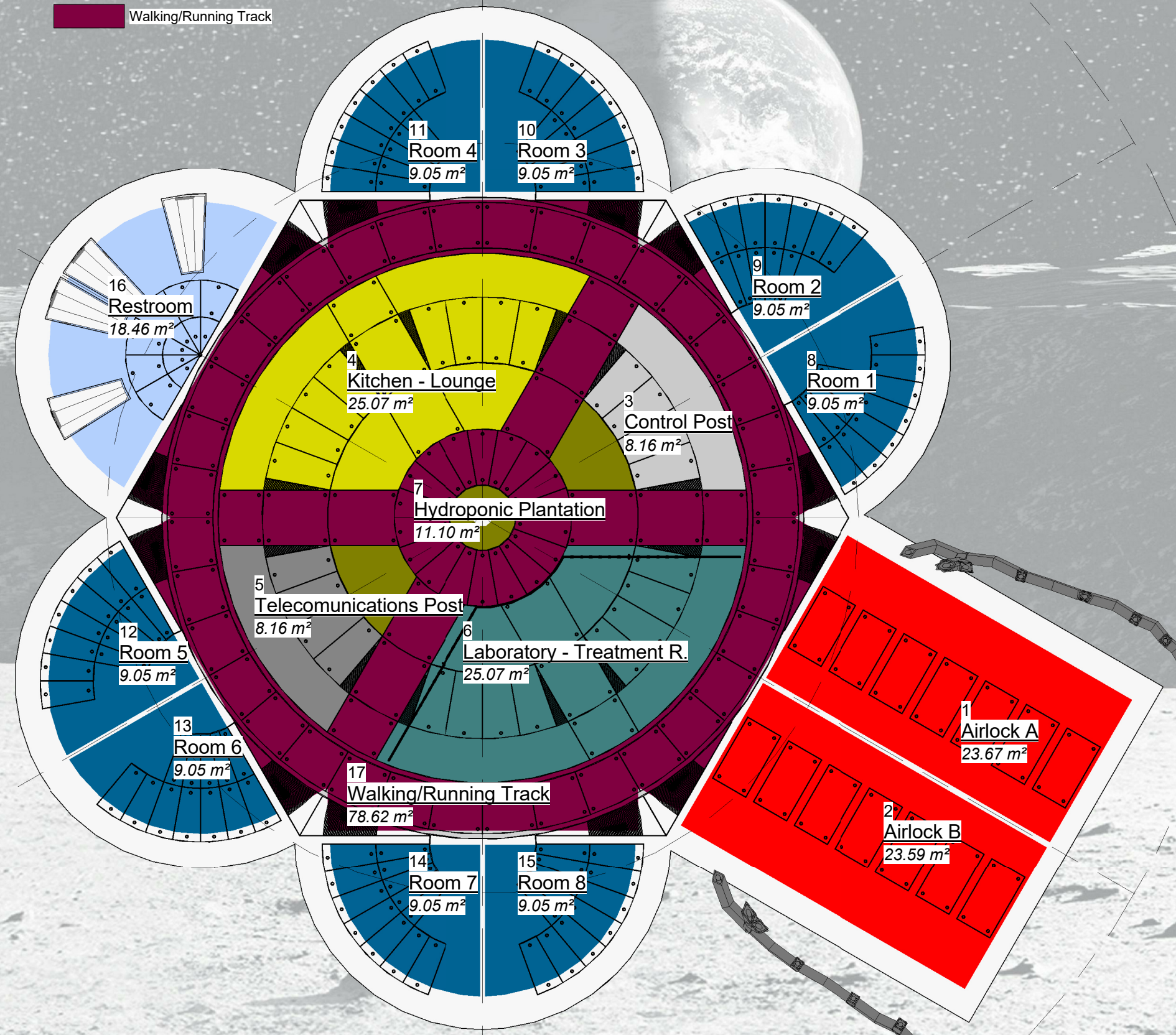
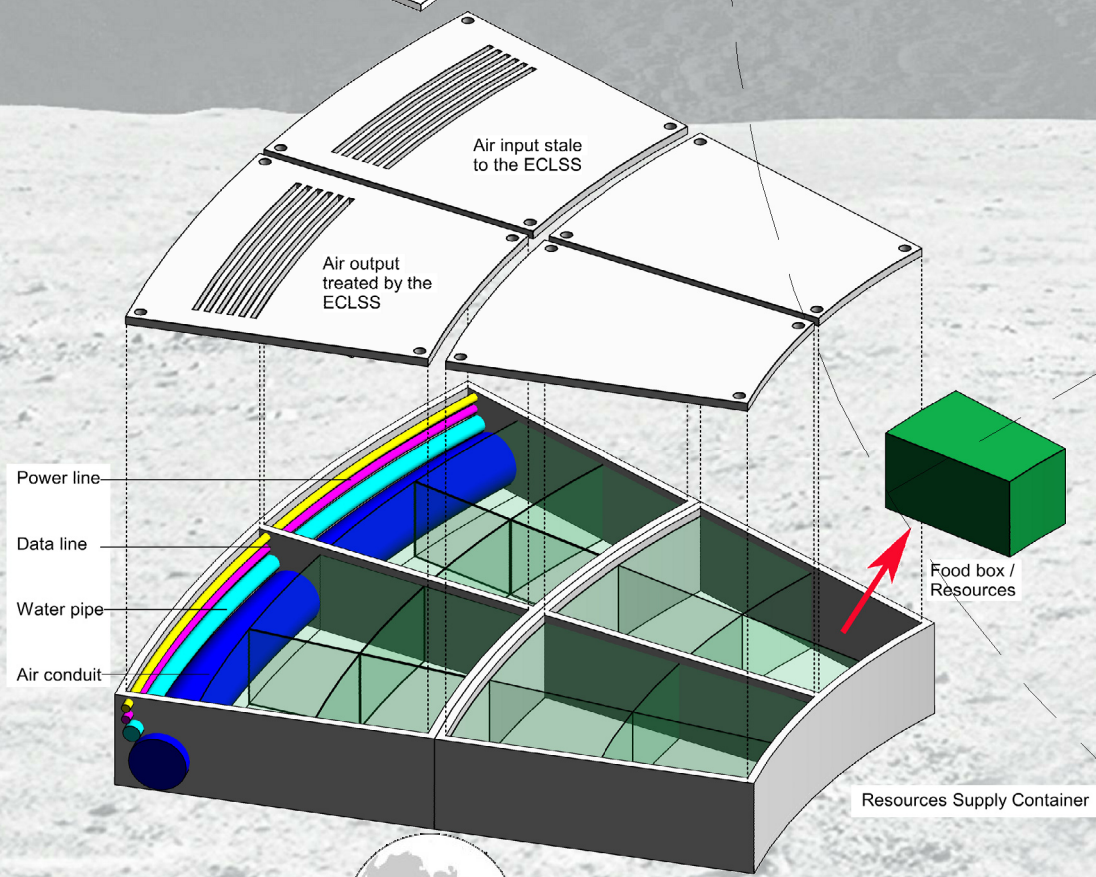
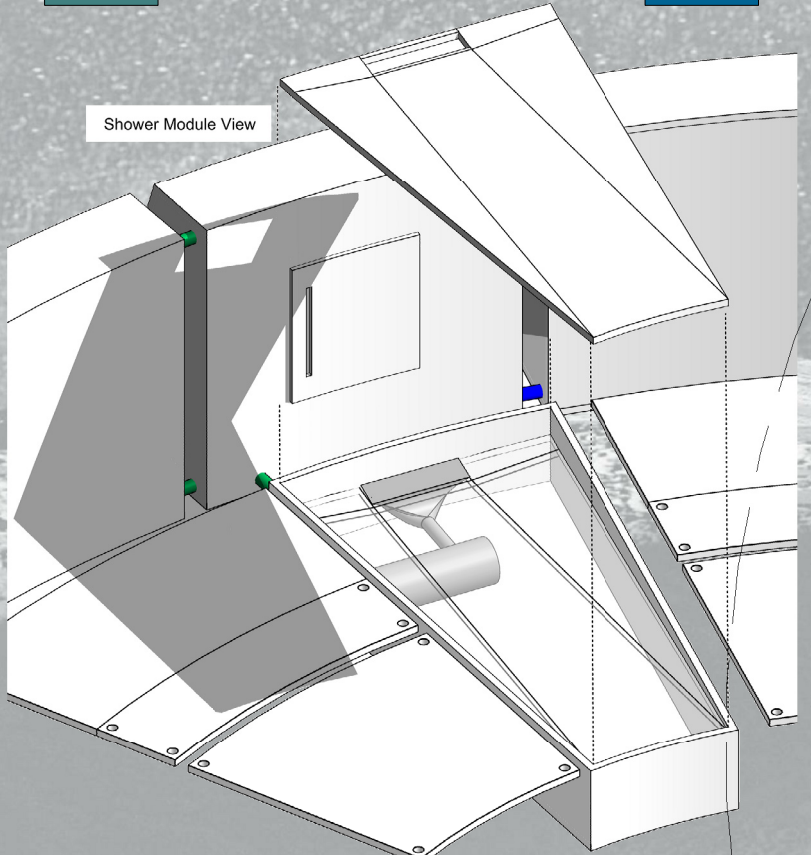

1 Level 1. AREA
02 1: 100

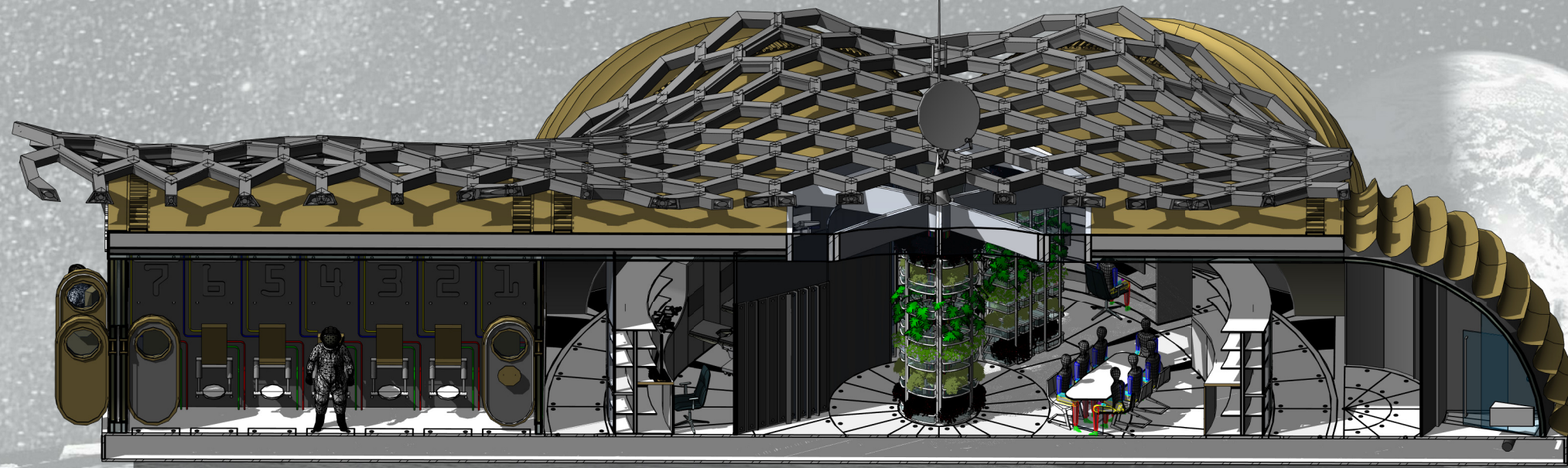

3D-S01 Airlock / Laboratory /
Hydroponic / Kitchen /
Restroom, Section Conic View
1

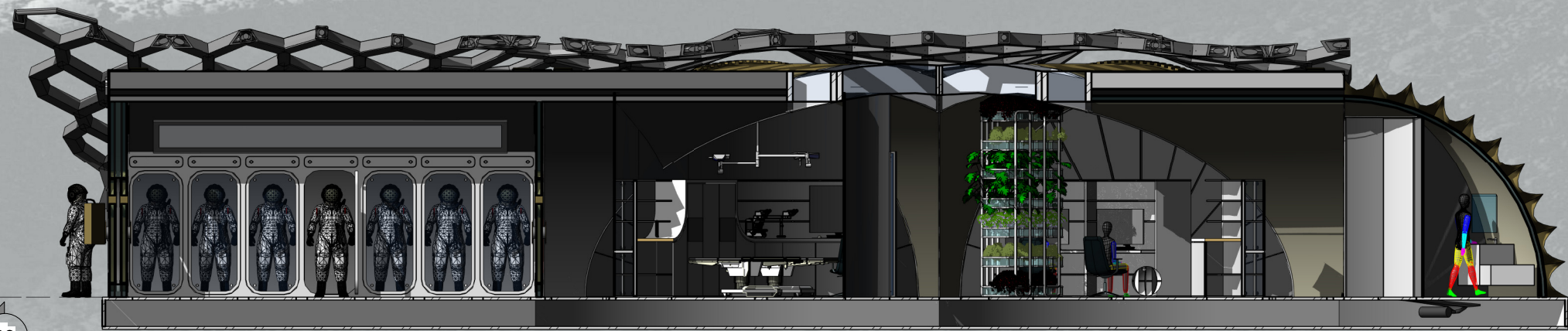

3D-S02 Airlock / Laboratory /
Hydroponic Plantation /
Kitchen / Restroom, Section
View 2

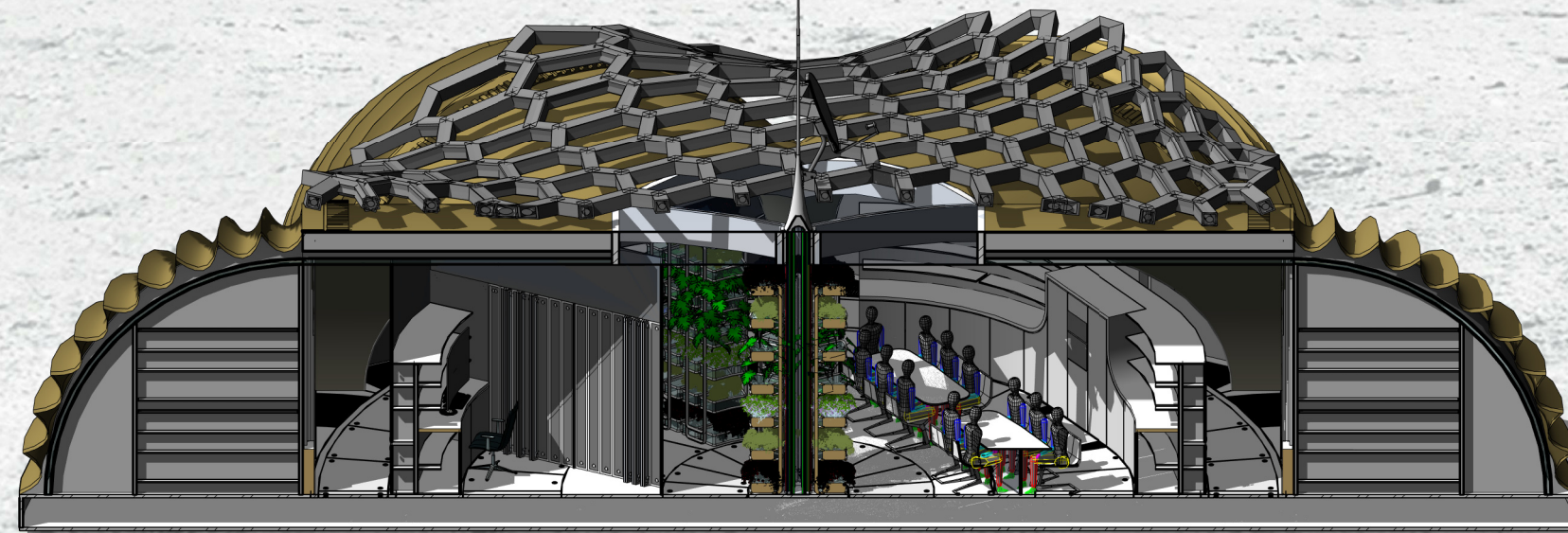
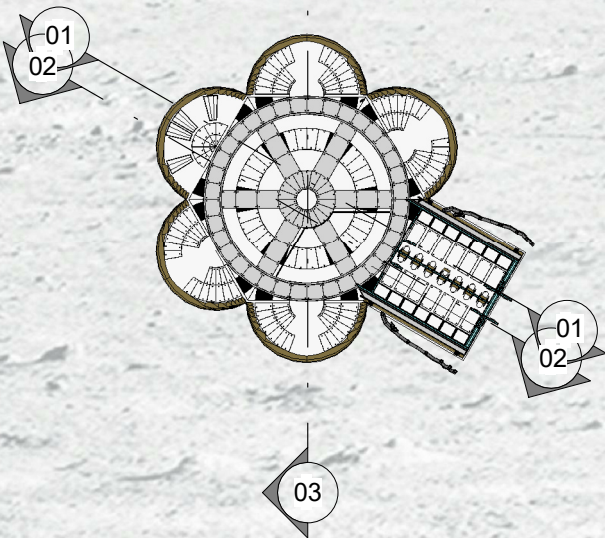

3D-S03 Laboratory /
Hydroponic Plantation /
Kitchen - Lounge, Section
Conic View 3

FLOORPLAN SECTIONS -
S01-02-03

PROMOTE:

THE MOON SOCIETY

PROJECT'S NAME: FOCARIS

N° 03. SECTIONS VIEWS 01-02-03

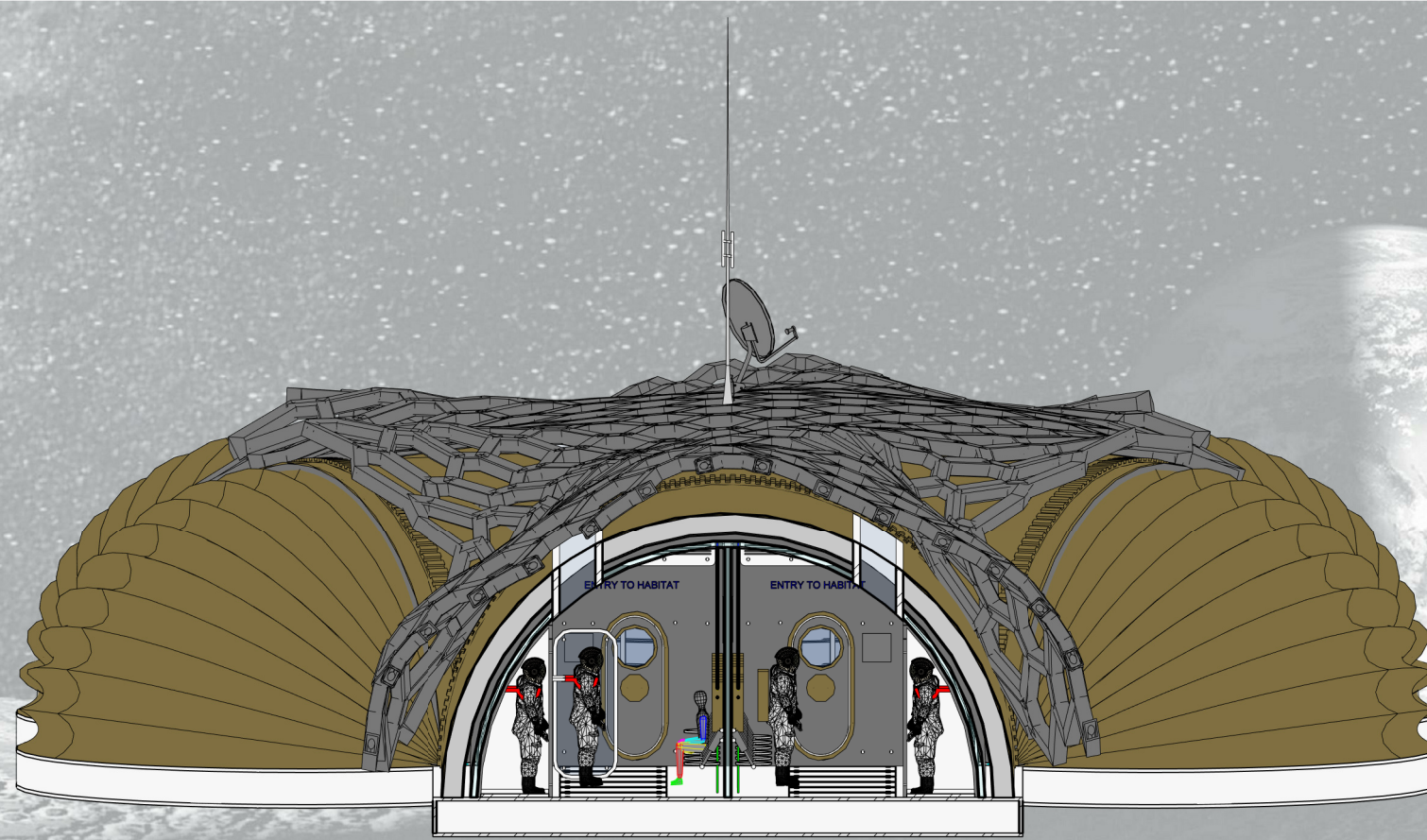

1	3D-S04 Airlock, Section Conic
04	View 4

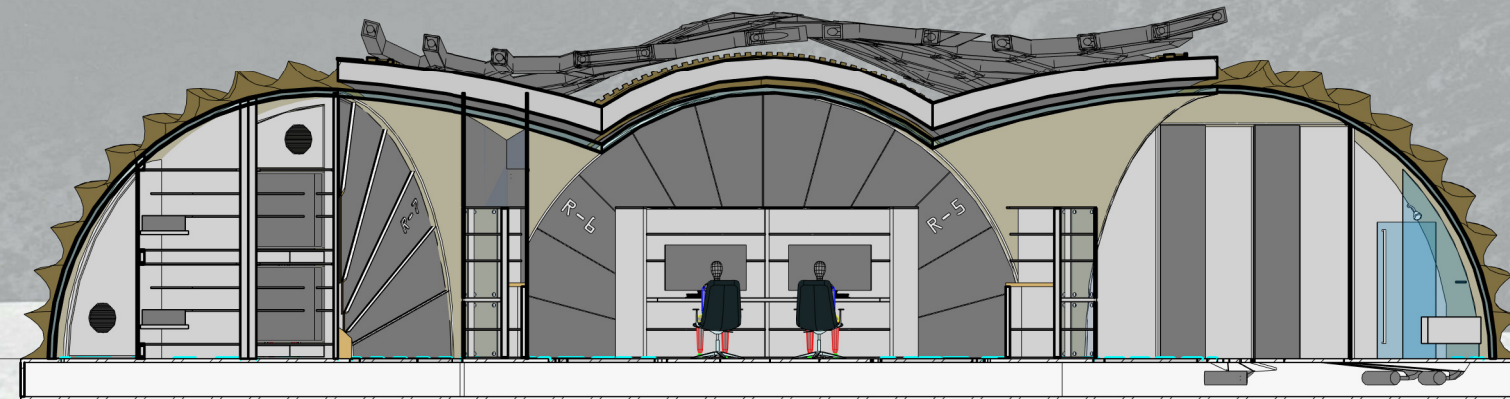

2	3D-S05 Room 7 /
04	Telecommunications Post /
	Restroom, Section View 5

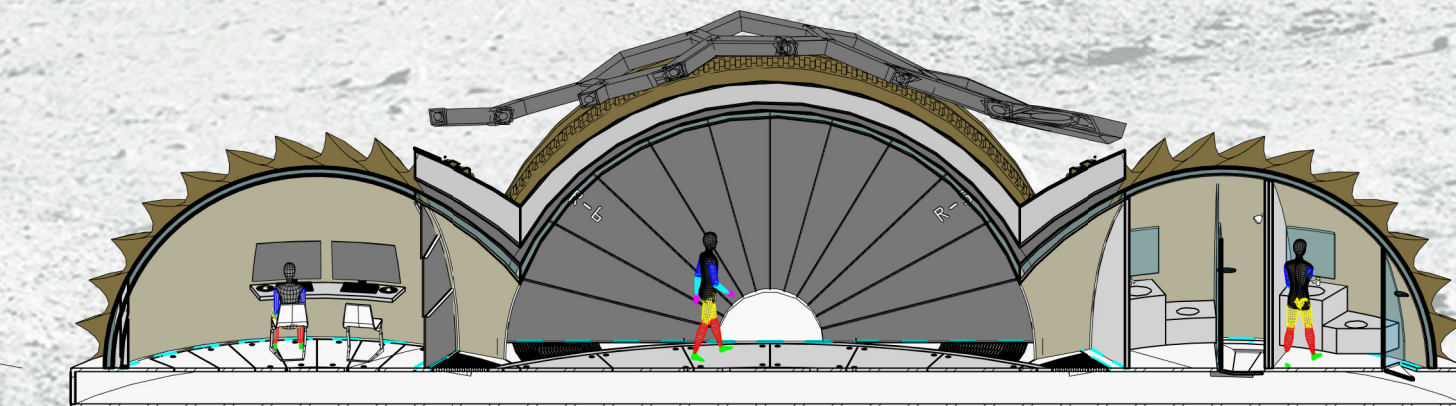

3	3D-S06 Room 7 / Entrance
04	Rooms 5-6 / Restroom,
	Section Conic View 6

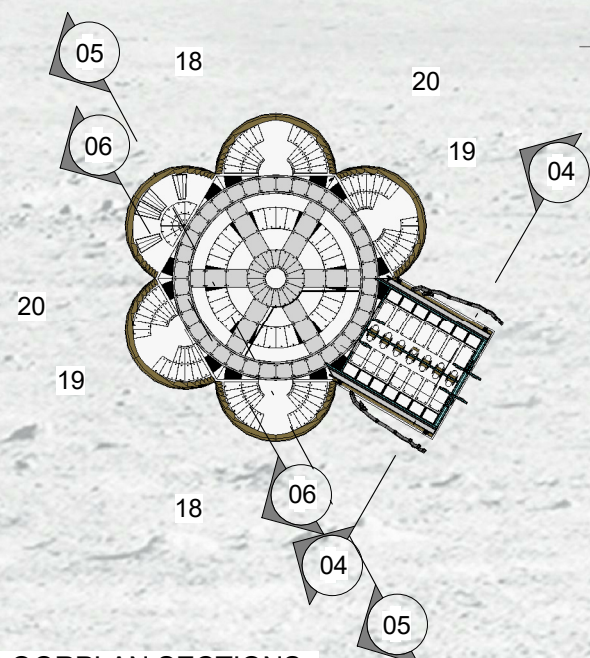

4	FLOORPLAN SECTIONS -
04	S04-05-06

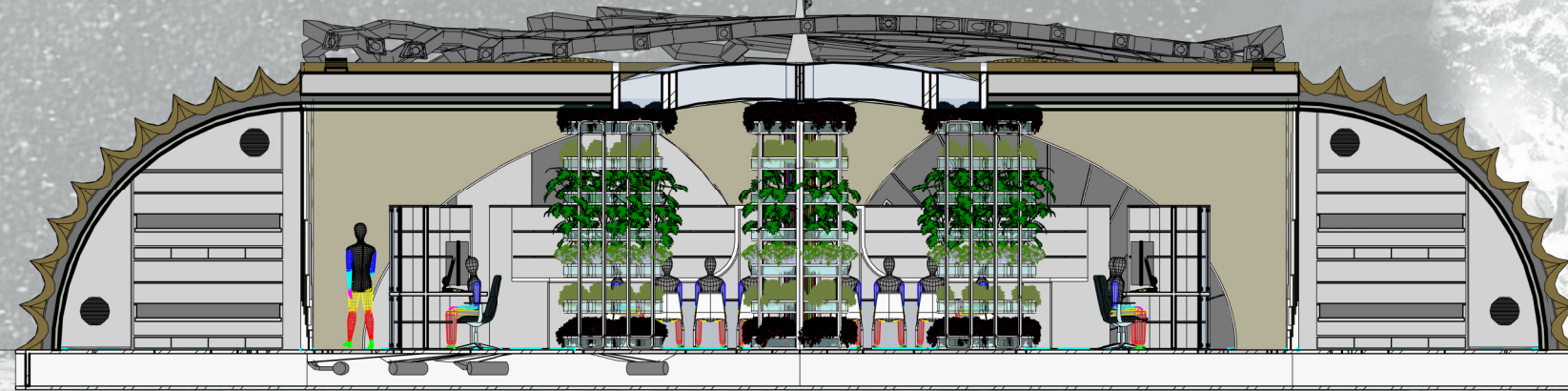

3D-S07 Room 6 /
Telecommunications Post /
Hydroponic
Plantations-Kitchen / Control
Post / Room 1, Section View 7

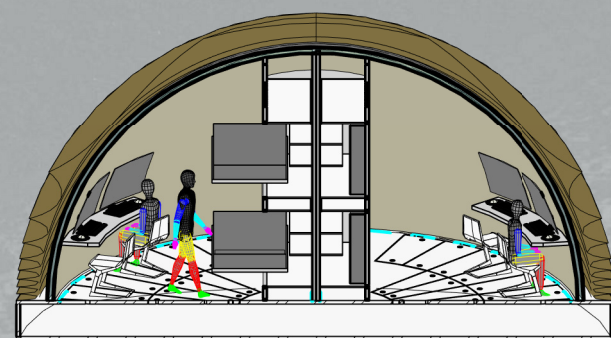

3D-S08 Rooms 5-6, Section
Conic View 8

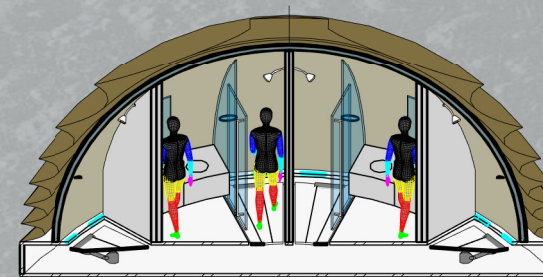

3D-S09 Restroom, Section
Conic View 9

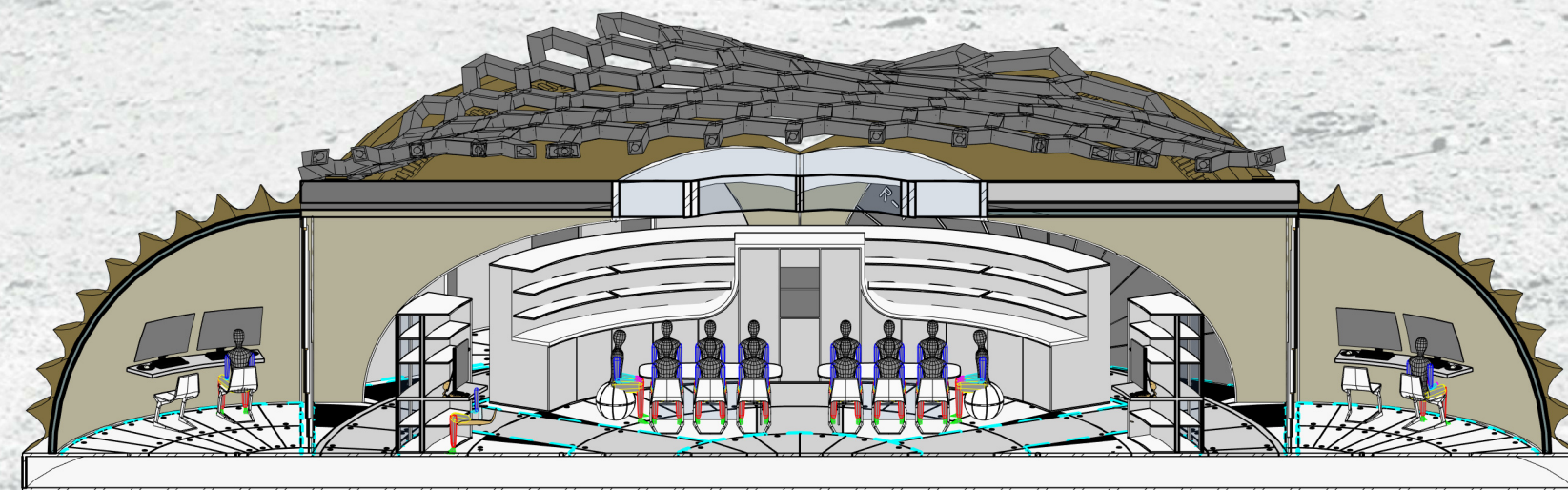
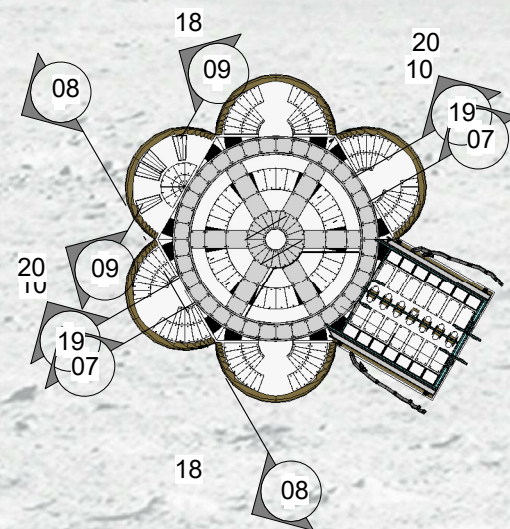

3D-S10 Room 5 /
Telecommunications Post /
Hydroponic
Plantations-Kitchen / Control
Post / Room 2, Section View 10

FLOORPLAN SECTIONS -
S07-08-09-10

PROMOTE:



PROJECT'S NAME: FOCARIS

Nº 05. SECTIONS VIEWS 07-08-09-10

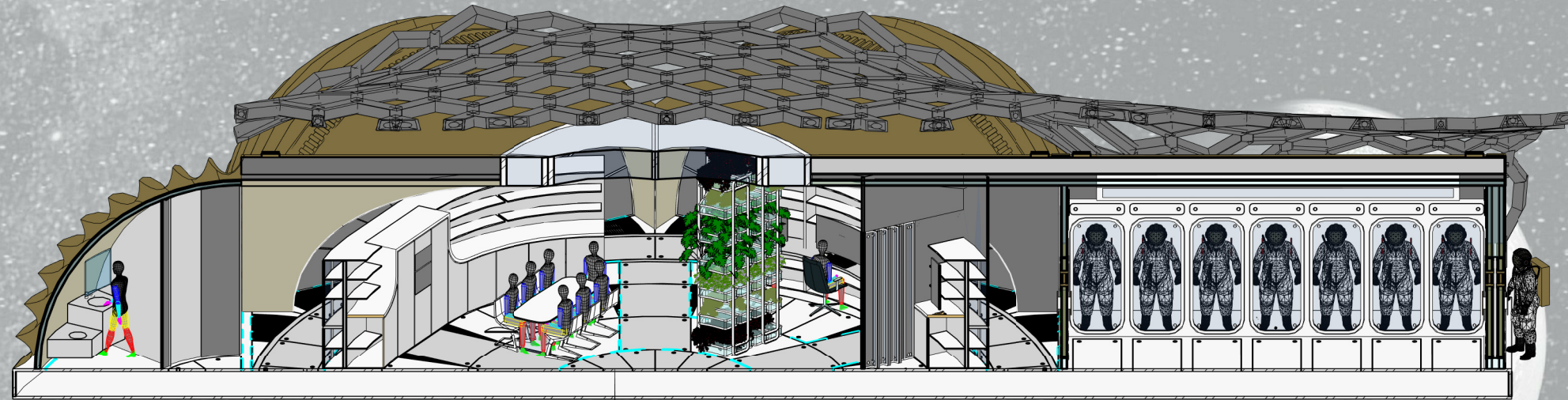

3D-S11 Restroom / Kitchen -
Lounge / Hydroponic
Plantation / Laboratory /
Airlock, Section Conic View
11



3D-S12 Restroom / Kitchen -
Lounge / Laboratory / Airlock,
Section View 12

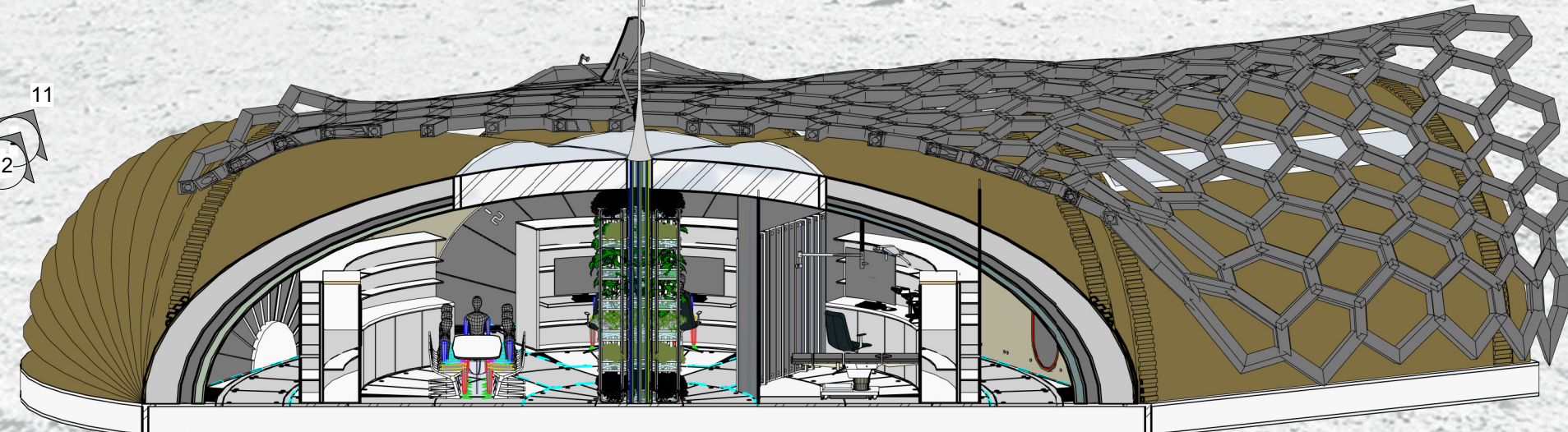
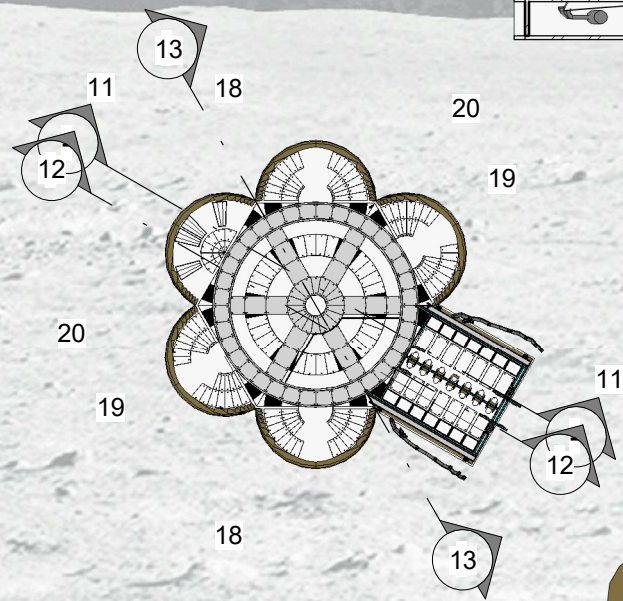

3D-S13 Kitchen / Hydroponic
Plantation /
Laboratory-Treatment Room,
Section Conic View 13

FLOORPLAN SECTIONS -
S11-12-13
1:300

PROMOTE:



PROJECT'S NAME: FOCARIS

N° 06. SECTIONS VIEWS 11-12-13

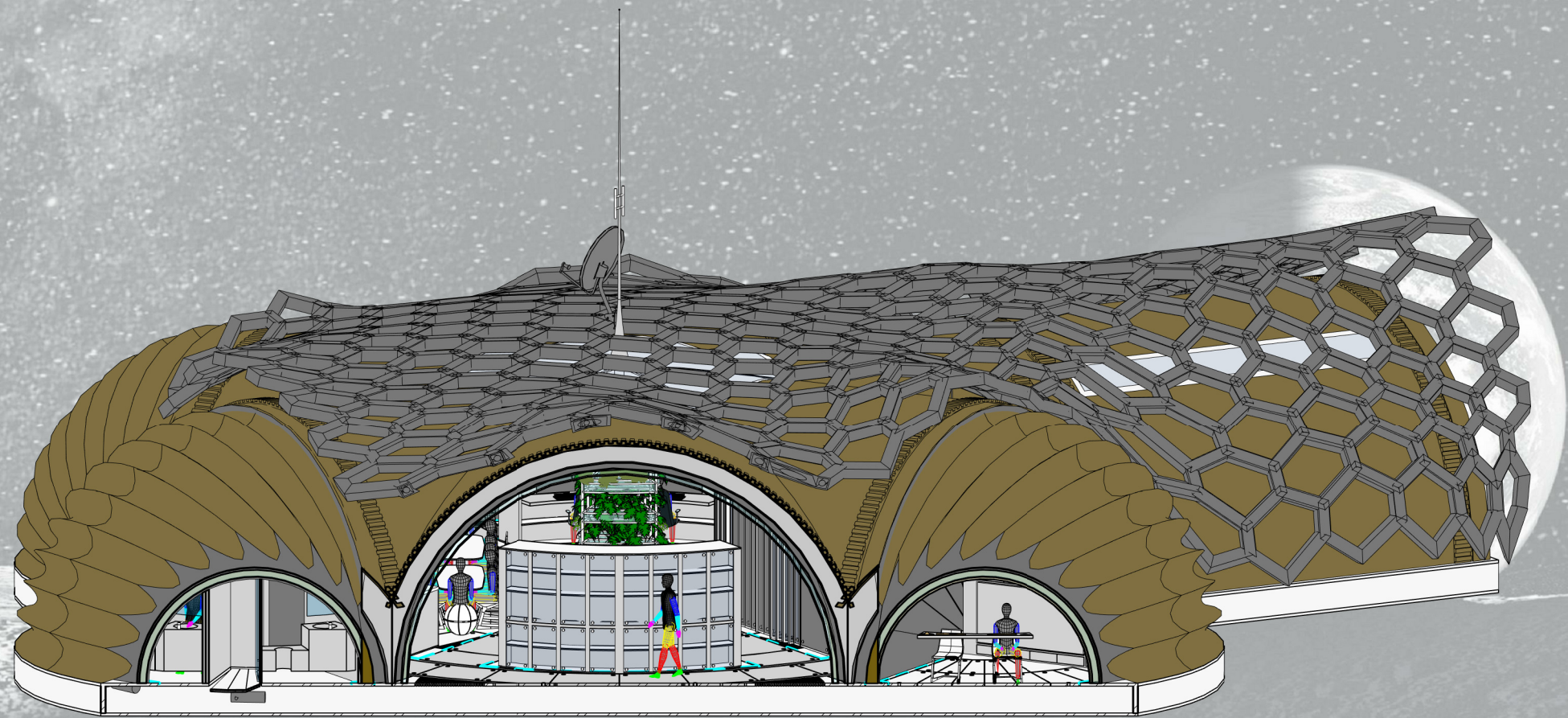

3D-S14 Restroom / Walking
 1 Track / Room 7, Section
 07 Conic View 14

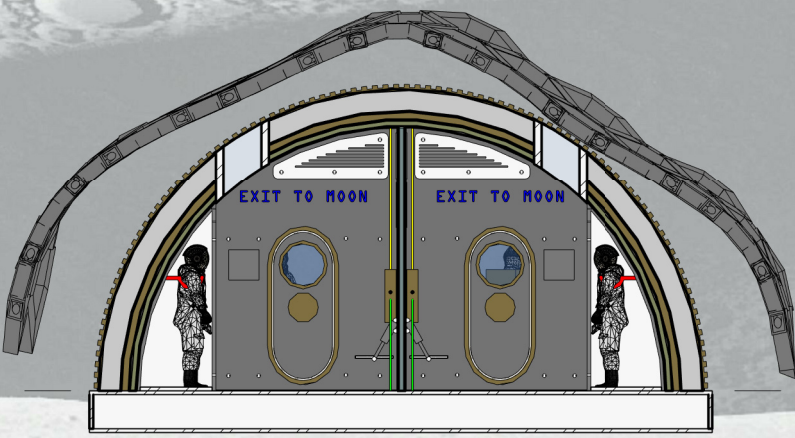

3D-S15 Airlock, Section View
 2 15
 07

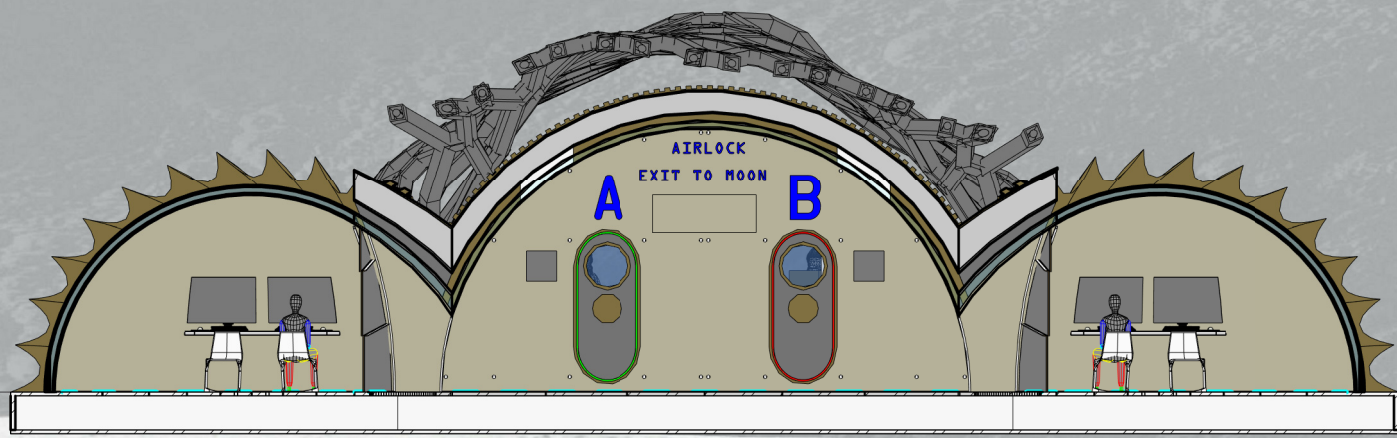

3D-S16 Room 1 / Entry to the
 3 Airlock from inside the Habitat
 07 / Room 8, Section View 16

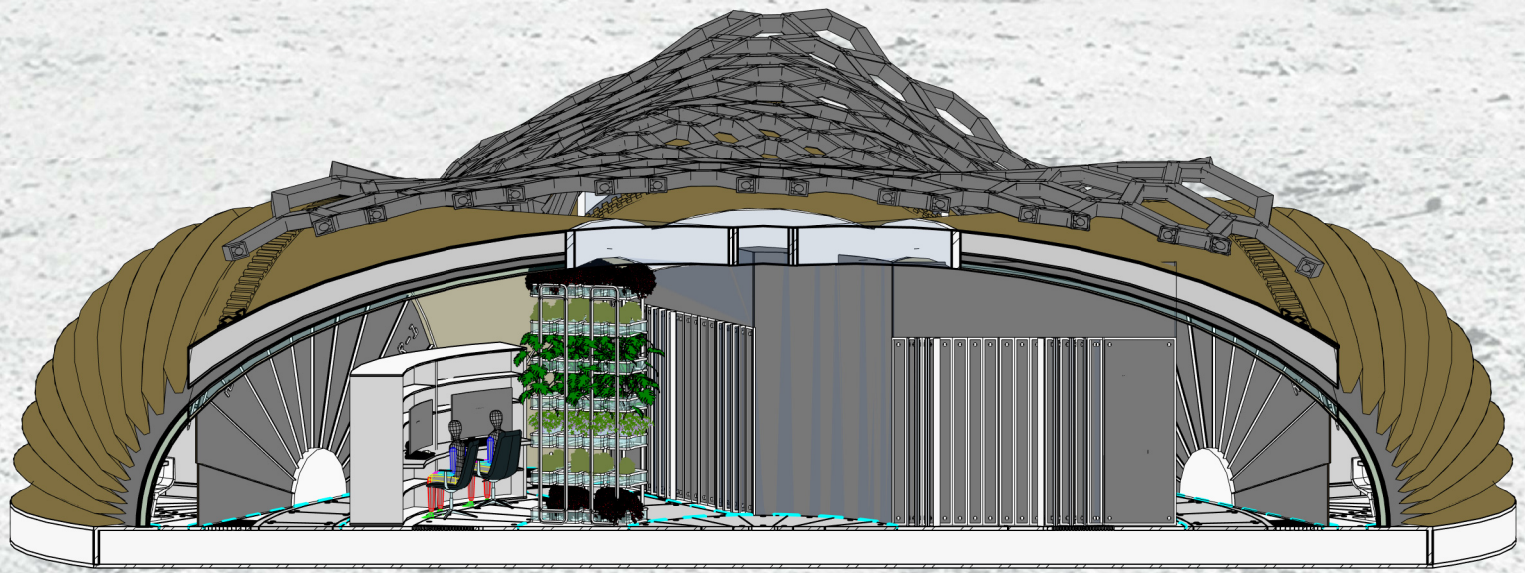
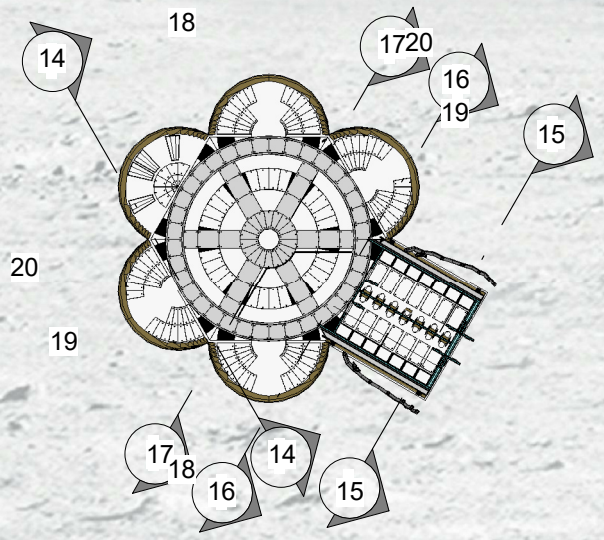

3D-S17 Entry Room 2 /
 4 Control Post / Entry
 07 Laboratory-Treatment Room /
 Entry Room 7, Section Conic
 View 17

5 FLOORPLAN SECTIONS -
 07 S14-15-16-17

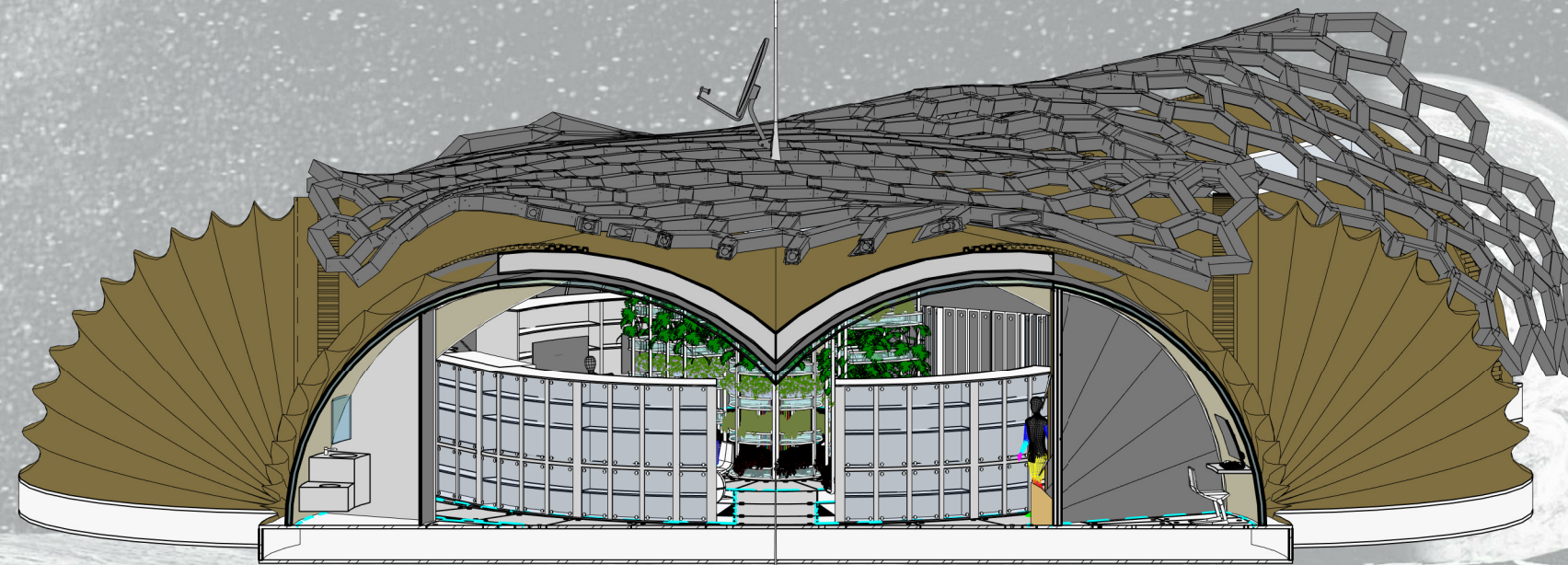

3D-S18 Restroom / Walking
 1 Track / Romm 6, Section
 08 Conic View 18

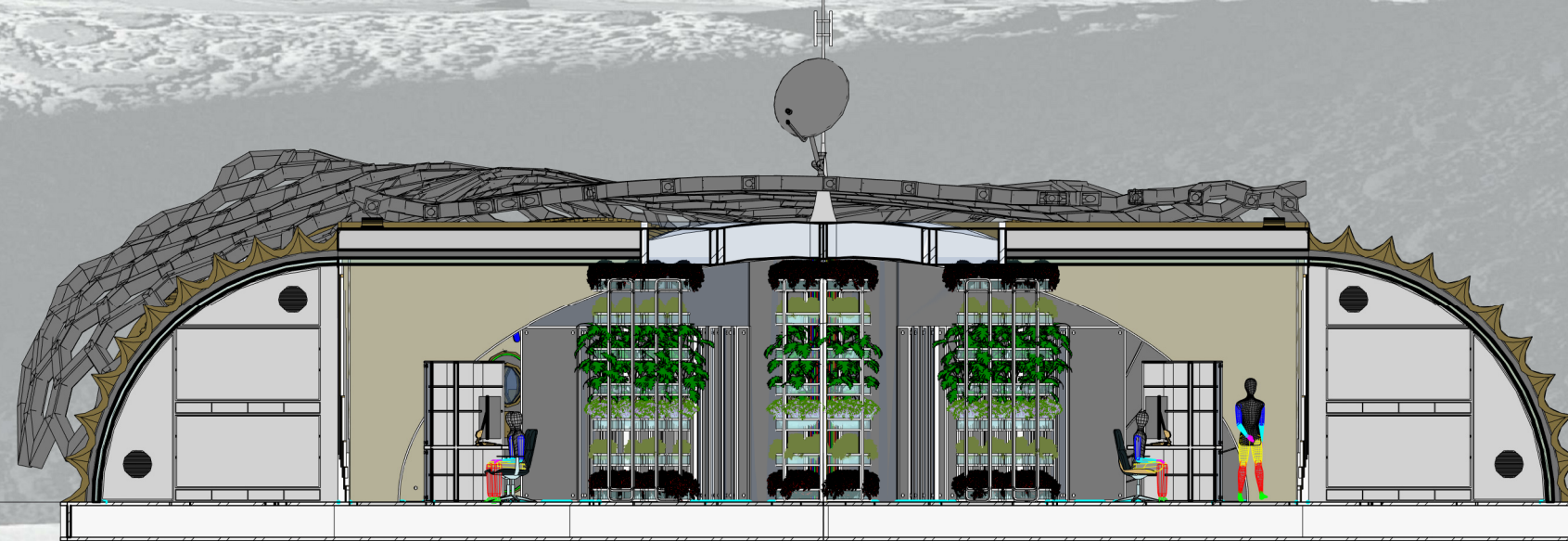

3D-S19 Room 2 / Control Post
 / Hydroponic Plantations /
 2 Telecommunications Post /
 08 Room 5, Section View 19

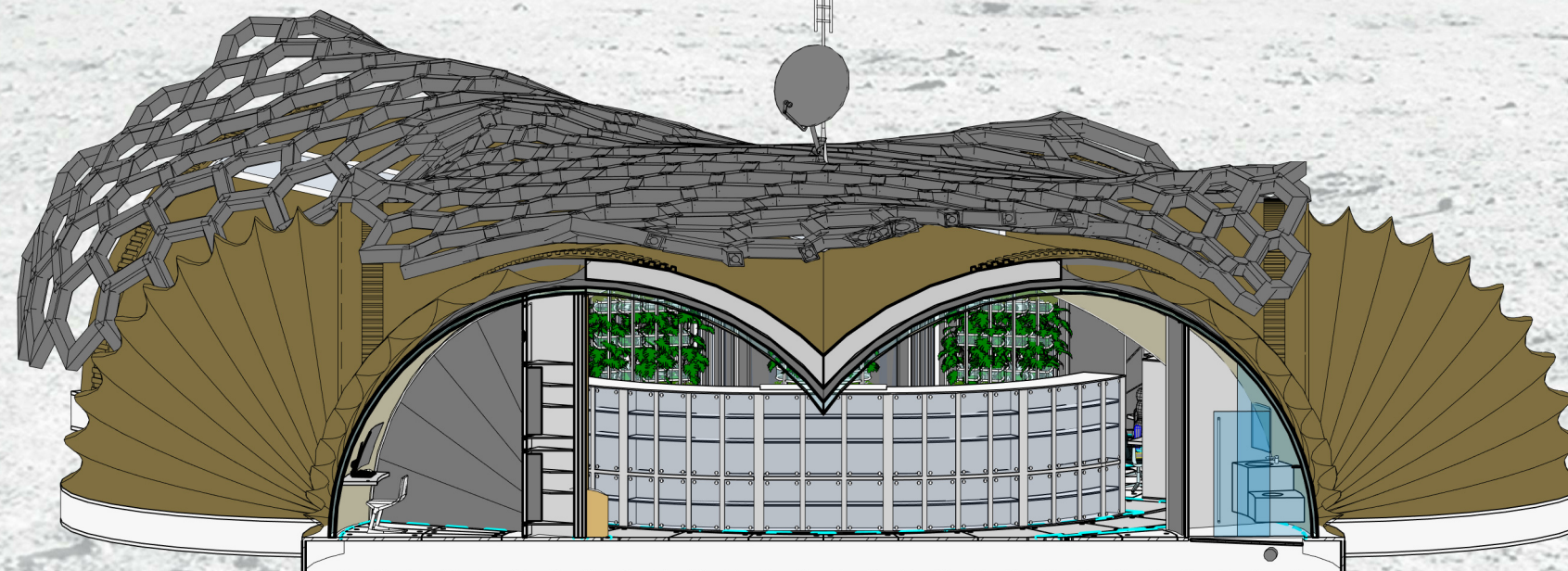

3D-S20 Room 3 / Walking
 3 Track / Restroom, Section
 08 Conic View 20

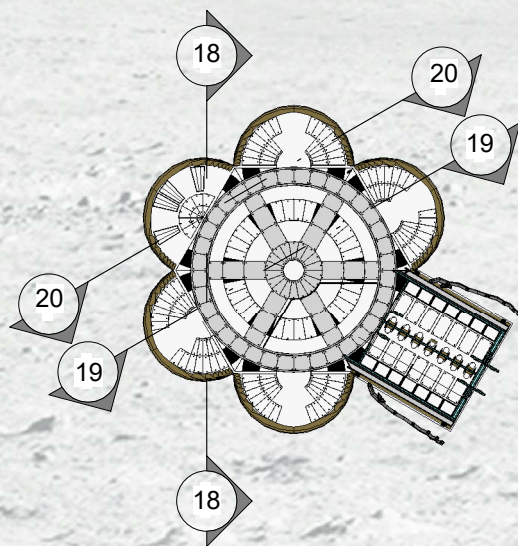

4 FLOORPLAN SECTIONS -
 08 S18-19-20

PROMOTE:



PROJECT'S NAME: FOCARIS

N° 08. SECTIONS VIEWS 18-19-20

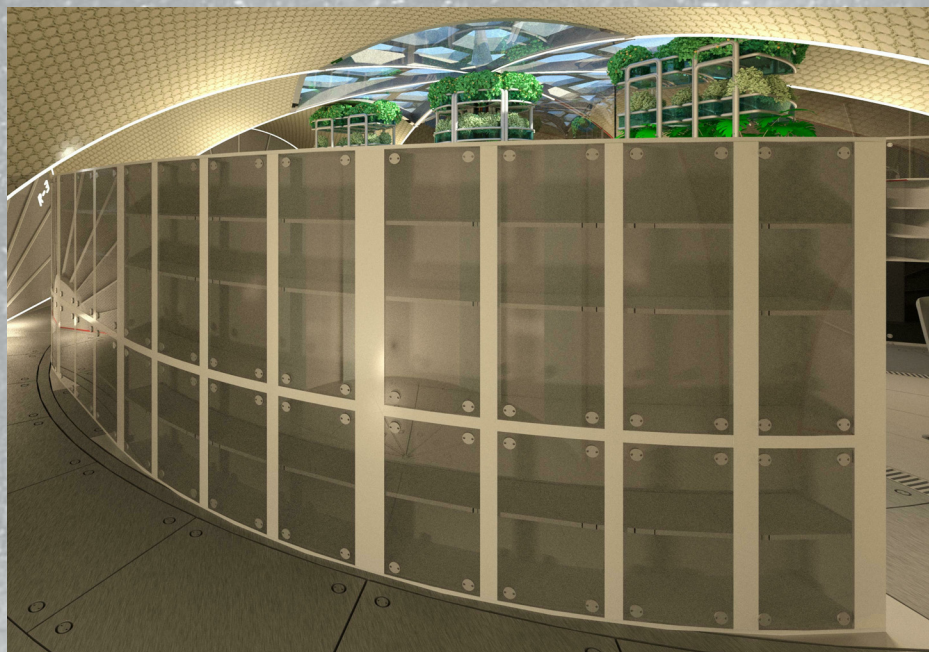

CURVED CORRIDOR VIEW

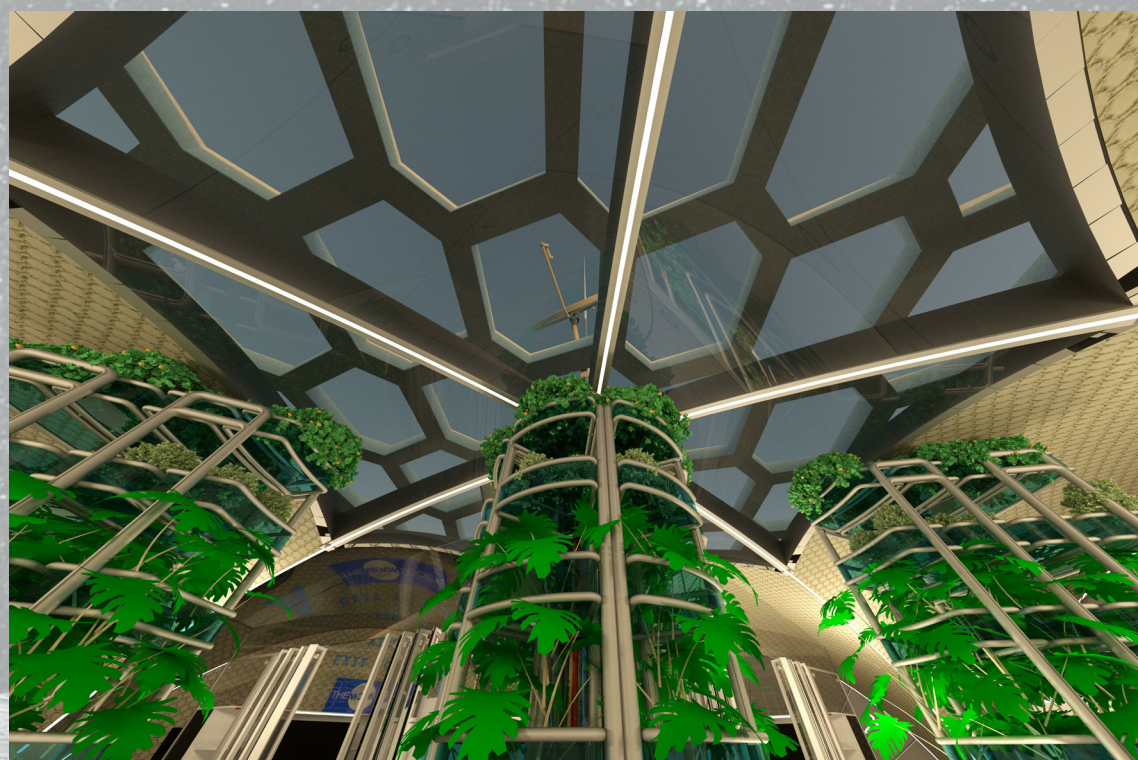

CENTRAL AREA VIEW



CORRIDOR VIEW

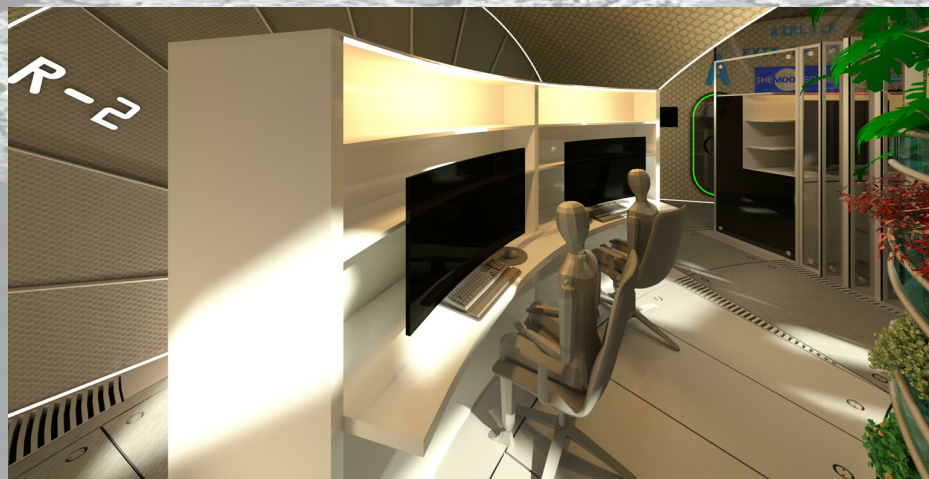

HABITAT CONTROL POST VIEW



KITCHEN VIEW

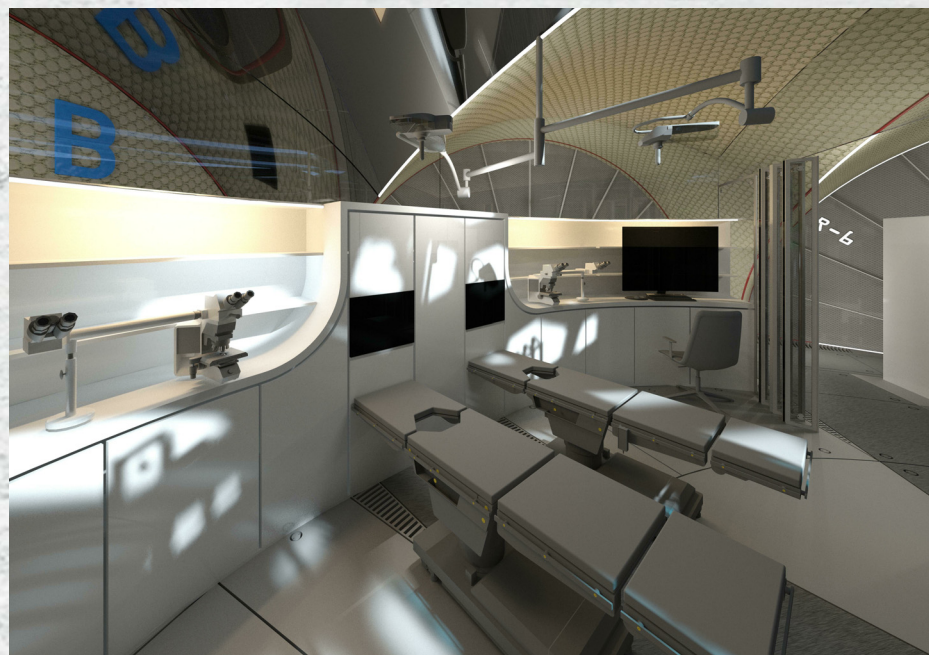

LABORATORY-TREATMENT VIEW_01

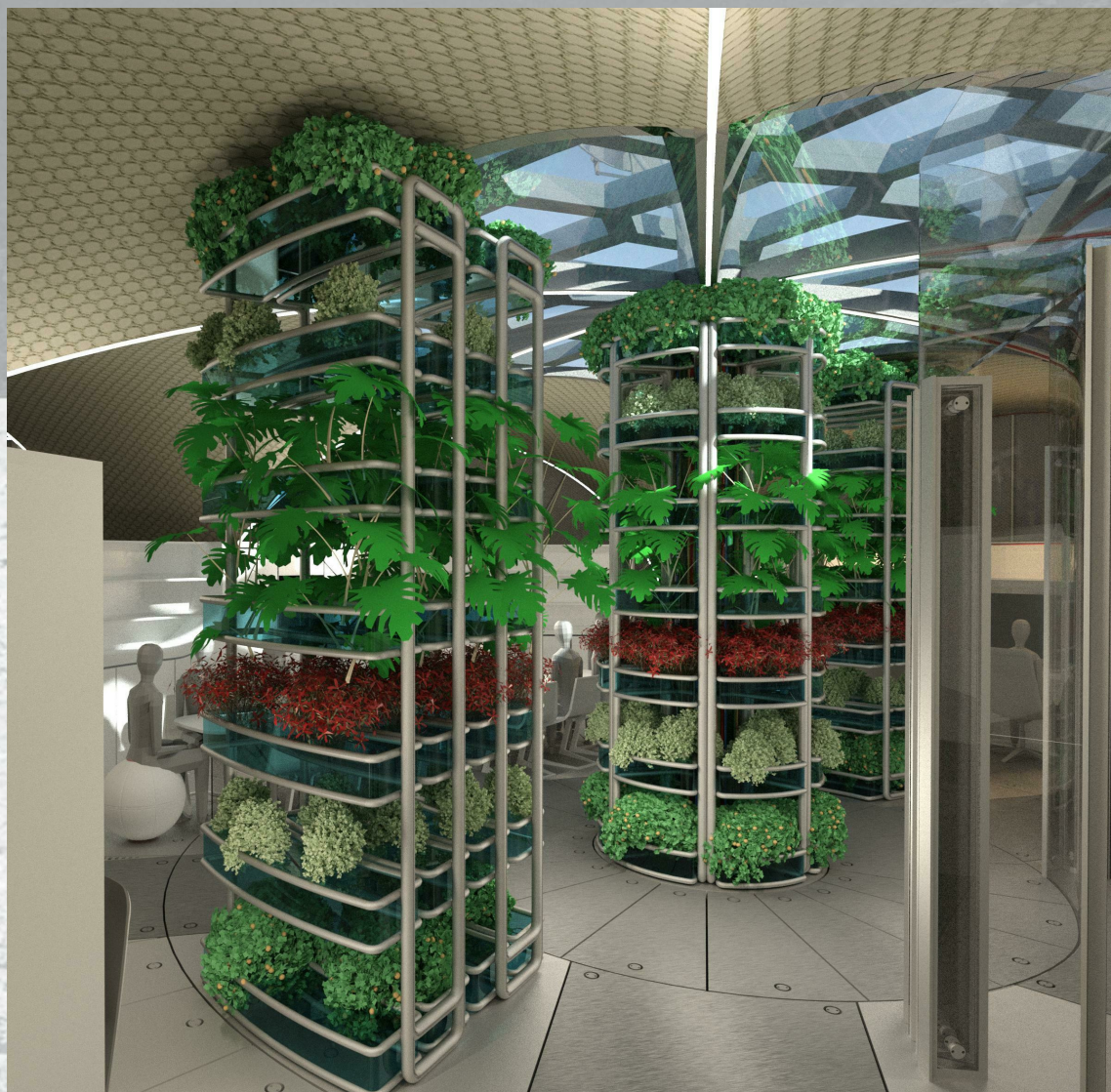

INTERIOR HIDROPONIC PLANTATIONS



LABORATORY-TREATMENT VIEW_02

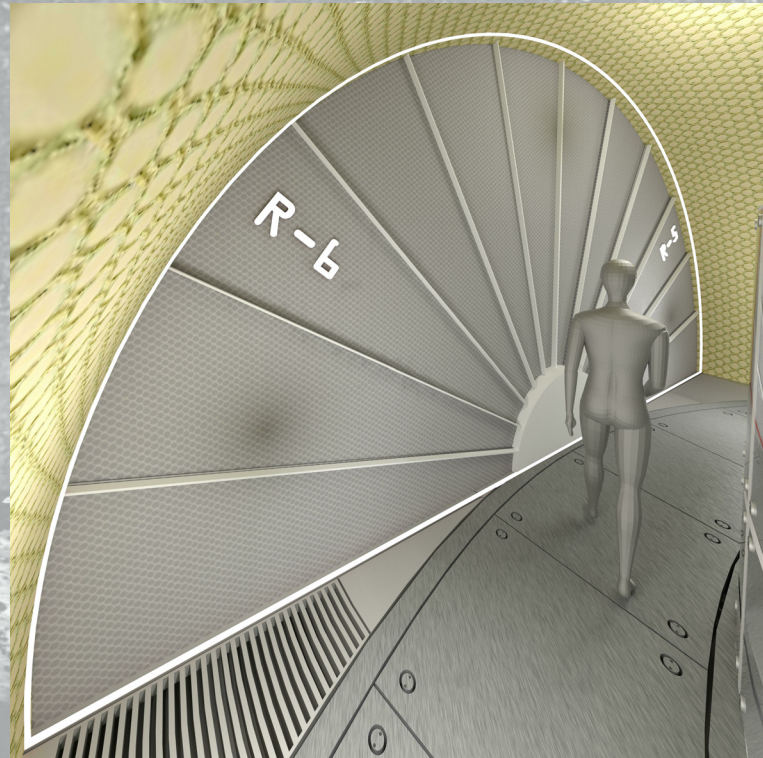

ACCESS TO ROOMS VIEW



AIRLOCK AREA VIEW 01 (N° 8 - 14 EXCHANGE POSTS)

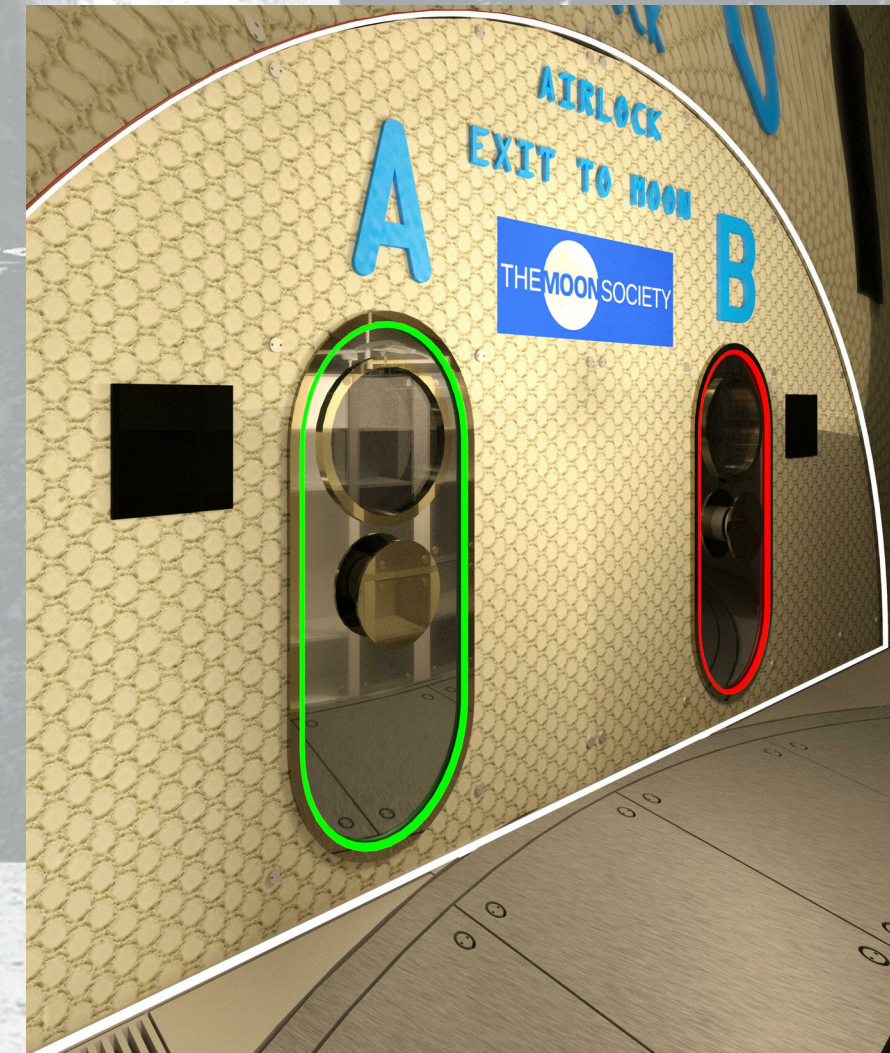

INPUT/OUTPUT TO AIRLOCK AREAS VIEW

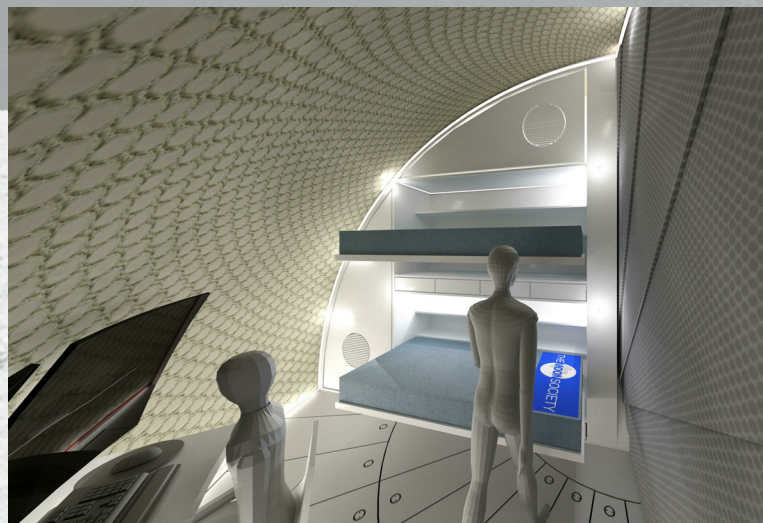

INTERIOR DOUBLE ROOM VIEW



AIRLOCK AREA VIEW 02 (N° 1 - 07 EXCHANGE POSTS)

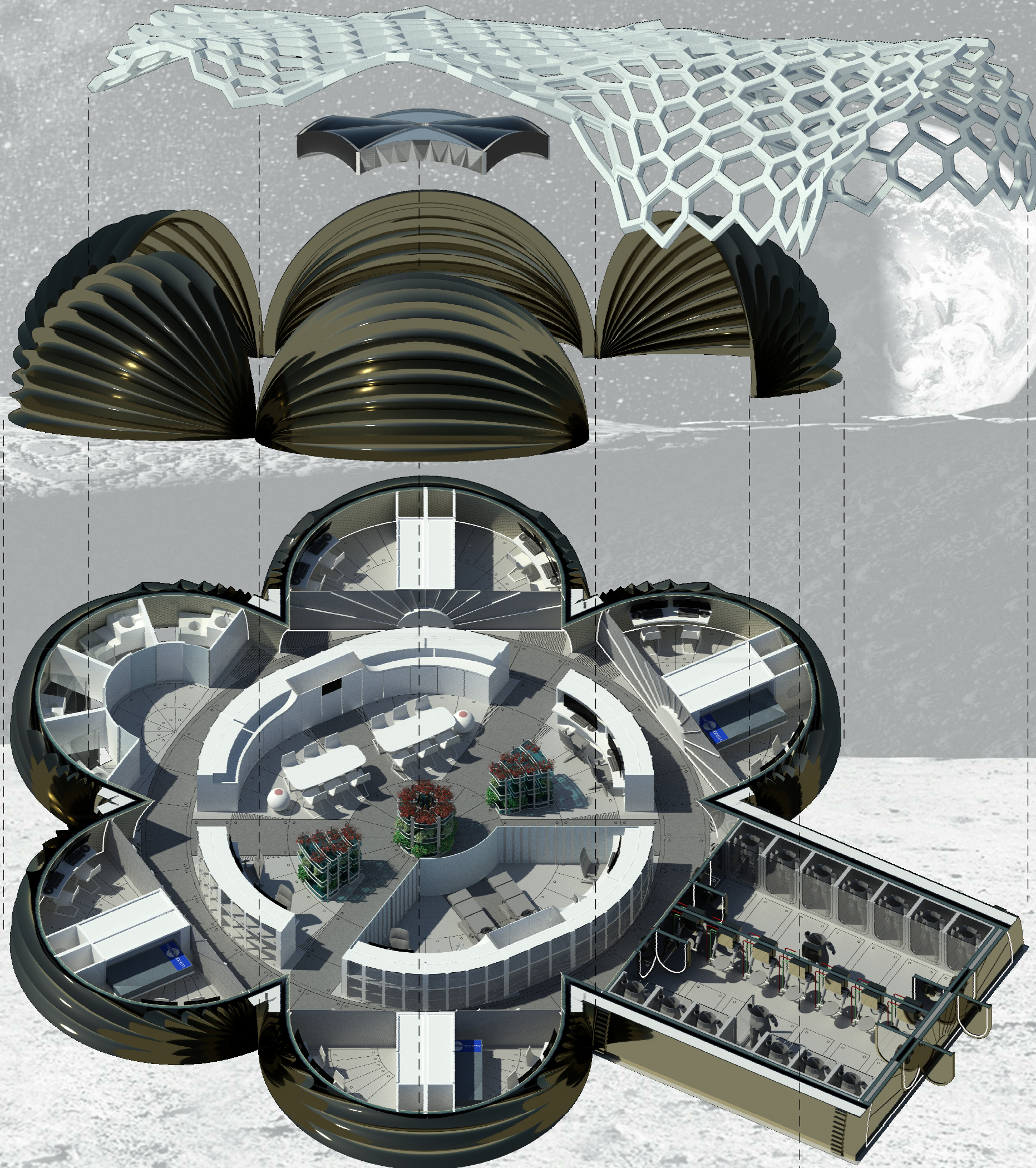

1 N°10. C01 Protective Skin
10 Focaris

2 N°10. C02 Central Skylight
10

3 N°10. C03 Pleated Domes
10

4 N°10. C04 Conceptual View of
10 Habitat

PROMOTE:



PROJECT'S NAME: **FOCARIS**

N° 11. CONCEPTUAL VIEW OF FOCARIS

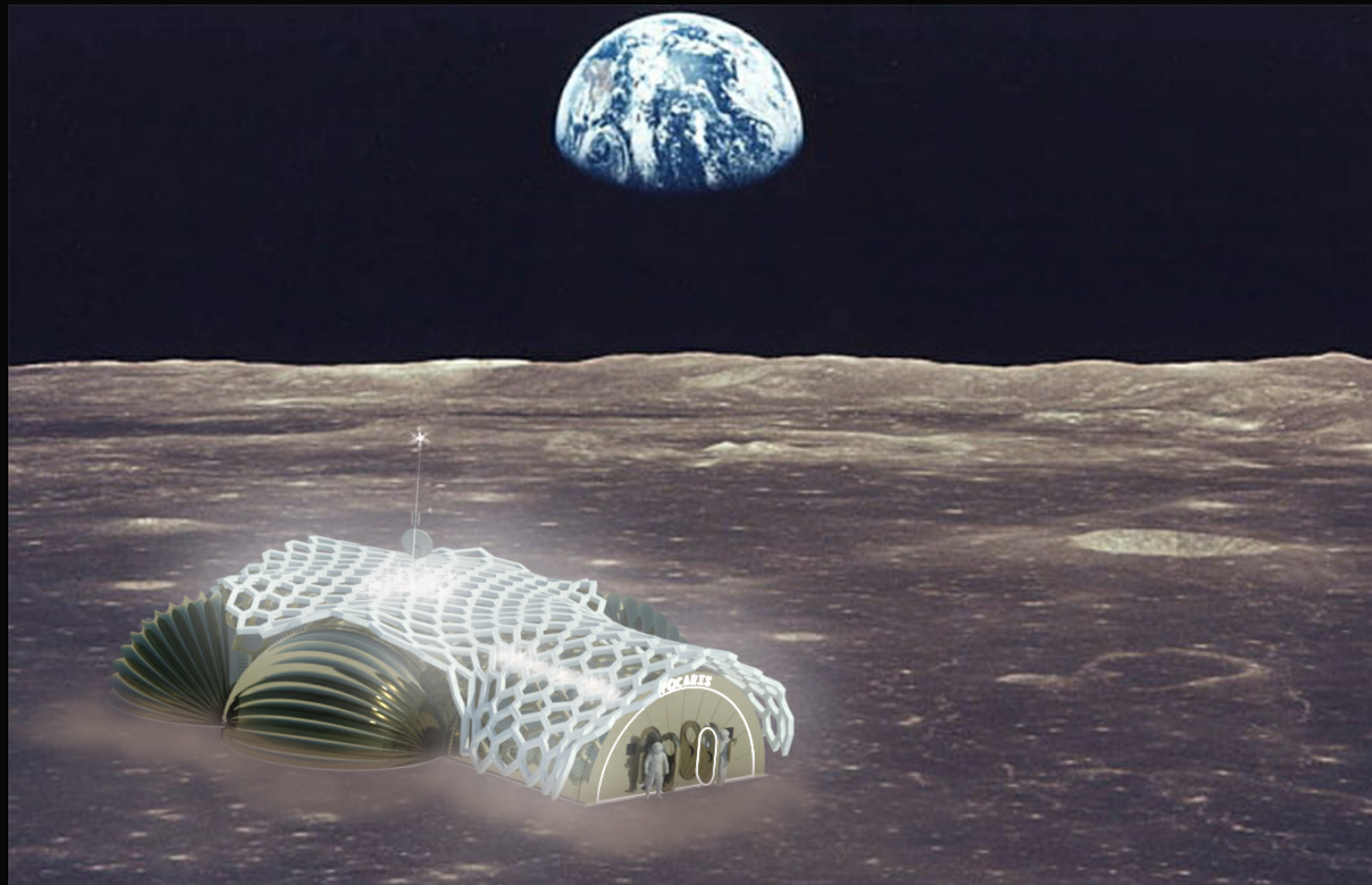

CONICAL AERIAL VIEW 1_R

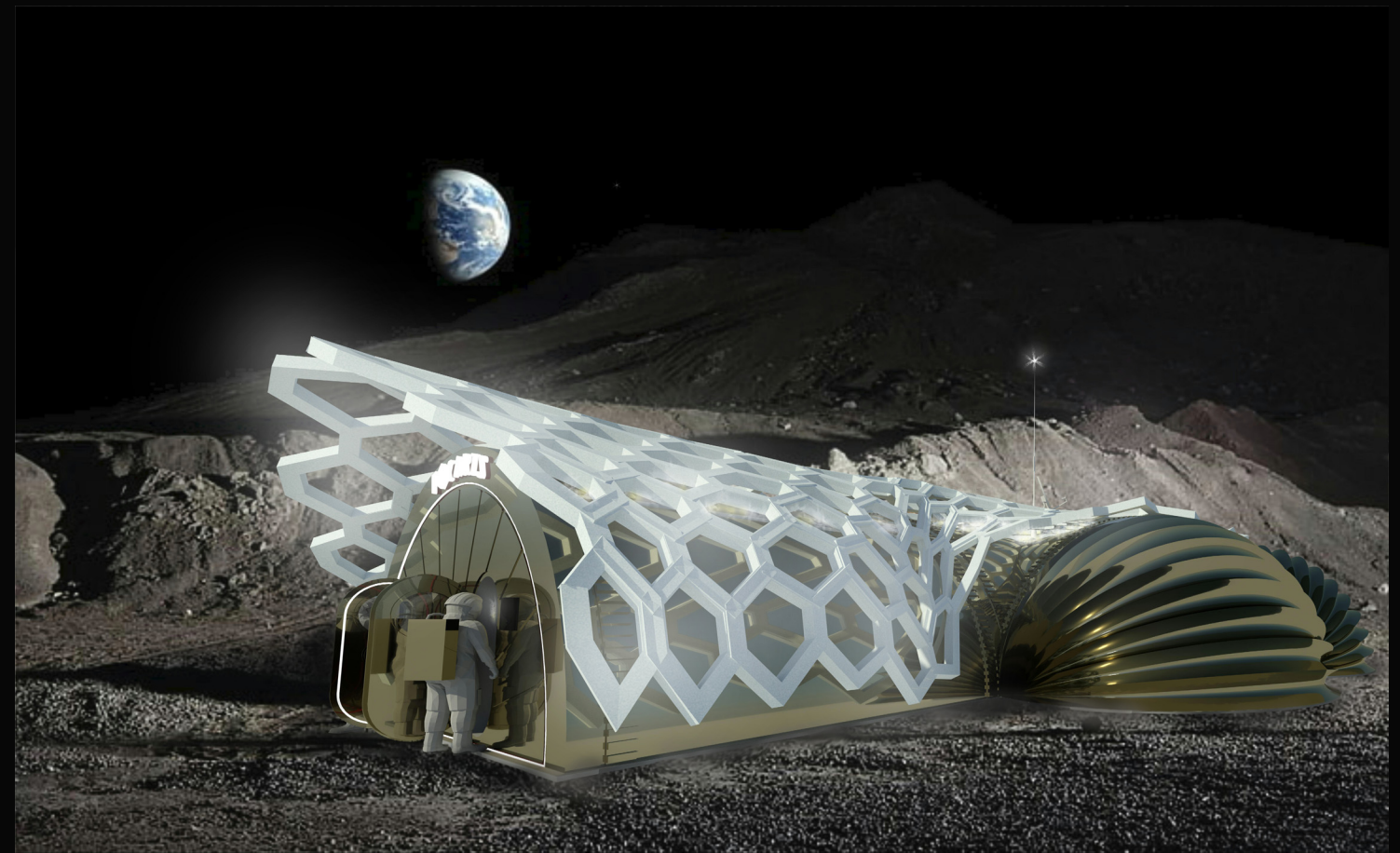

CONICAL FRONT VIEW ENTRY TO THE AIRLOCK 1_R

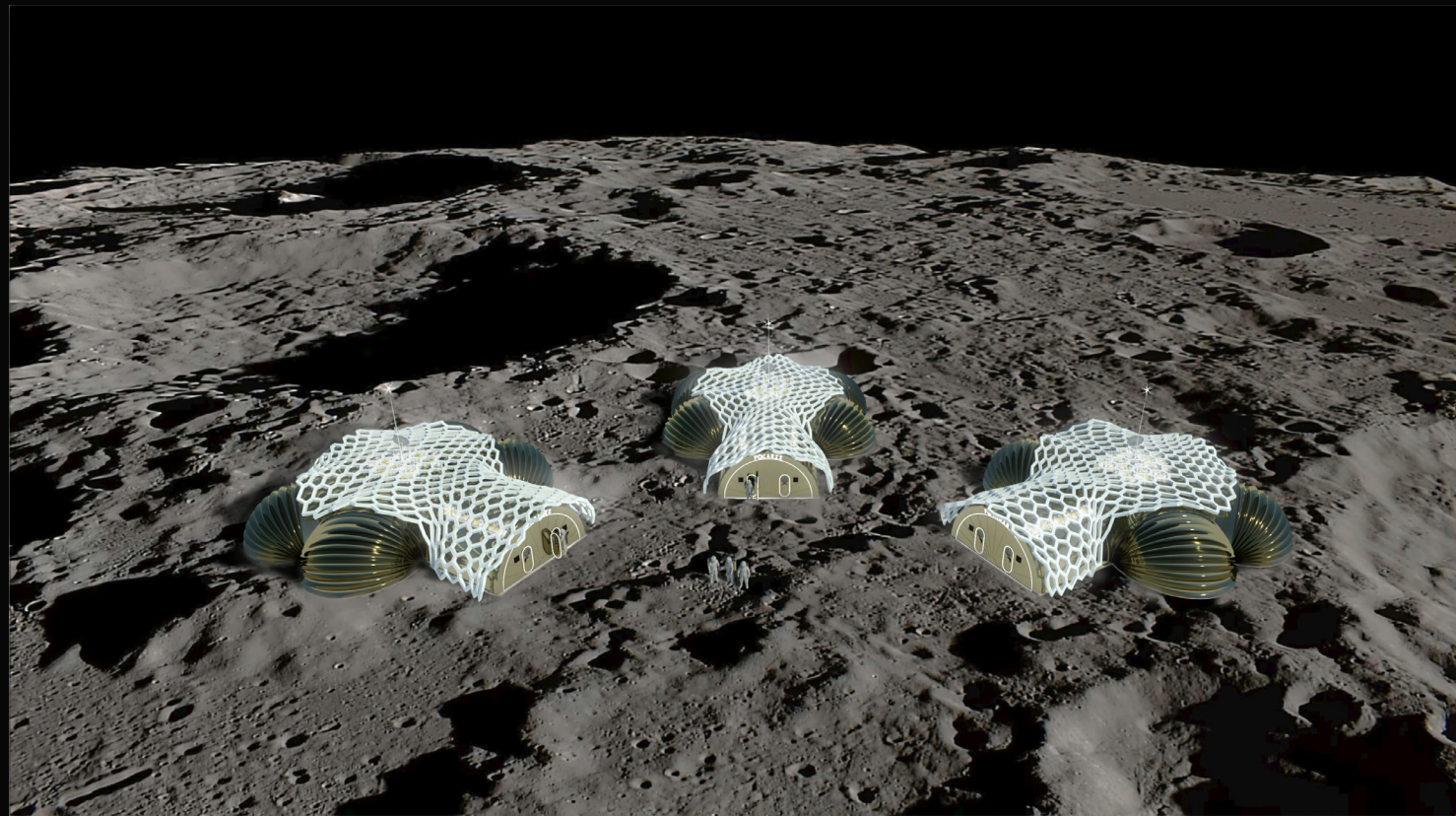

COLONY CONICAL AERIAL VIEWS_R

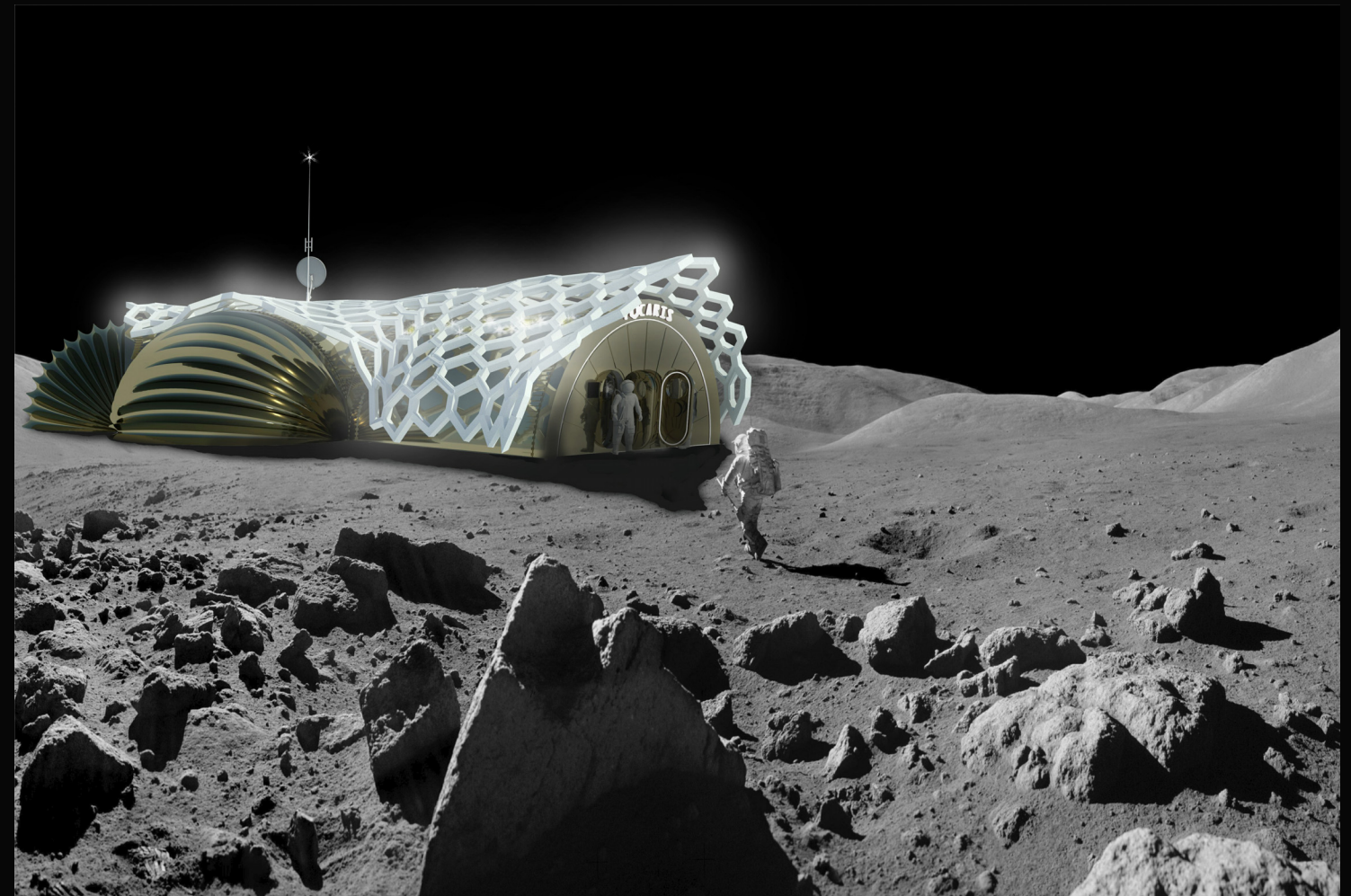

CONICAL FRONT VIEW ENTRY TO THE AIRLOCK 2_R

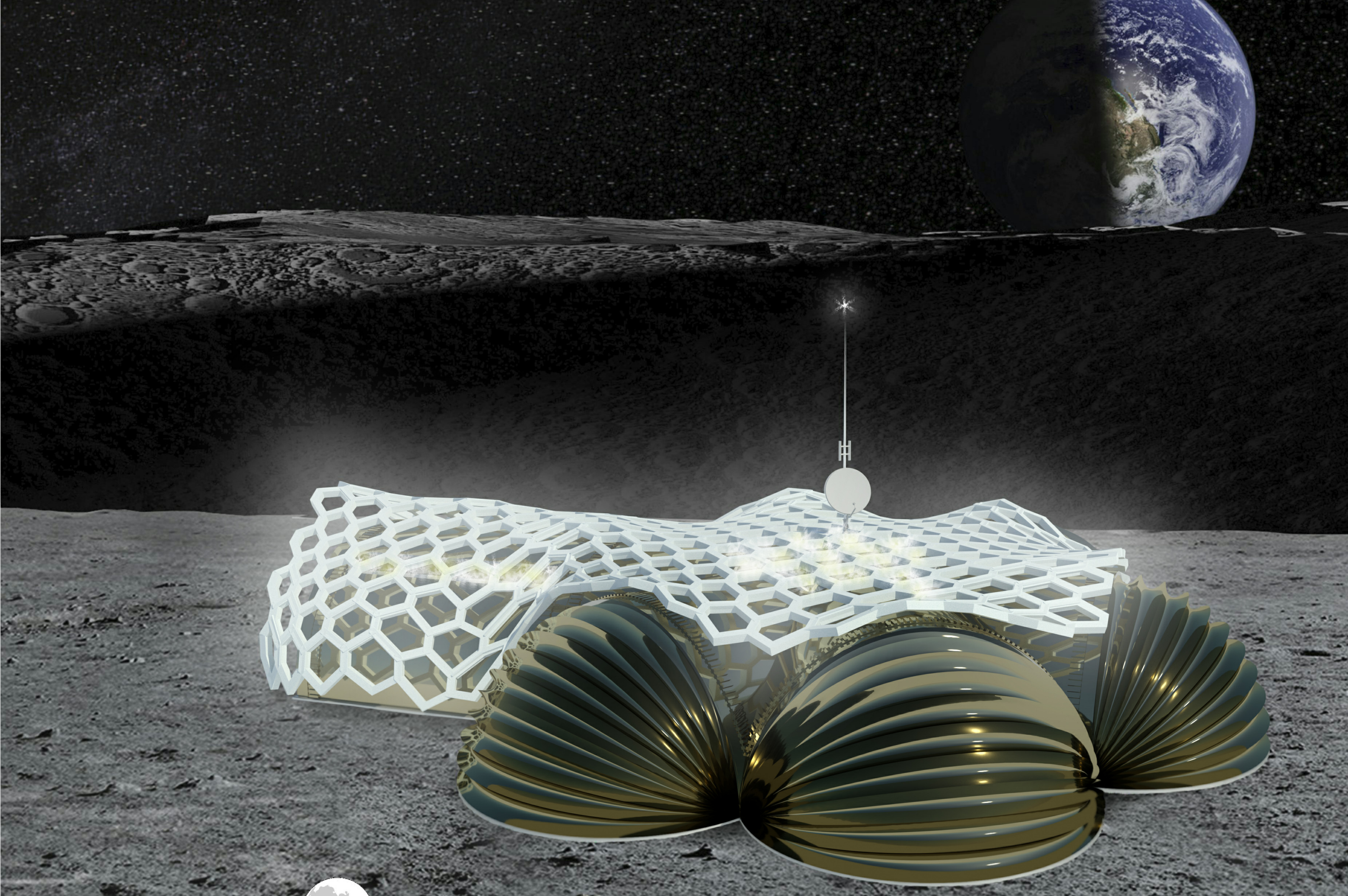

PROMOTE:

THE MOON SOCIETY

PROJECT'S NAME: FOCARIS

N° 13. MAIN 3